



Woodworking

with [Larry Eastman](#) Your Guide to One of Over [700 Sites](#)

Search for

[Home](#) · [Recent Articles](#) · [Visit Forums](#) · [Chat Live](#) · [Contact Guide](#) · [Free Newsletter](#)

Subjects

[Adhesives/Glues](#)
[Antique Tools](#)
[Bandsaws](#)
[Conversion Charts](#)
[Education](#)
[Finishes](#)
[Free Catalogs](#)
[Hand/Power Tools](#)
[Kiln Drying](#)
[Machinery](#)
[Magazines](#)
[Museums/Galleries](#)
[Planers](#)
[Plans Index](#)
[Pneumatic Tools](#)
[Safety/Supplies](#)
[Sawmills](#)
[Software](#)
[Supplies](#)
[Tablesaws](#)
[Tips/Techniques](#)
[Tole Painting](#)
[TV Shows](#)
[Unfinished Items](#)
[Web Articles](#)
[Web Rings](#)
[Wooden Kits](#)
[Wood/Components](#)
[Woodworkers' Sites](#)
[Hardware](#)

[Subject Library](#)

[All articles on this topic](#)

Free Woodworking Plans

Whenever possible I locate free plans on the internet, and occasionally I draw some up that hopefully will be beneficial to you. On the following four pages you will find a list of both types of free plans.

We all would like to see more free plans available to us at a click of the mouse. There are many unique [plans available on the internet](#).

There are links to thousands of plans on this Woodworking site. More plans will be added on a regular basis. If you can't locate a plan at this time, please take advantage of this Woodworking.About.com's [Forum](#). Someone may see your posted question, and know exactly where you can find what your looking for, or perhaps you can help out another fellow woodworker, by answering a question they may have.

Free Plans From the Internet A-C

[Aldo Leopold Bench](#)

Wild Ones has a free bench plan that is made from 2" x 6", 2" x 8", and 2" x 10" material.

[Aquarium Table](#) new

An article that describes how to make a table that can support a 3' long fish tank. The table also includes a shelf underneath. Material list measurements are in millimeters.

[Artist's Easel](#)

Benjamin Grosser shows how to build a heavy duty easel with free drawings and instructions.

[Baby Changing Table](#)

Amateur Woodworker has instructions, and a

Related Sites

from About

[Architecture](#)
[Basketry](#)
[Decorative Arts](#)
[Folk Art](#)
[Forestry](#)
[Home Repair](#)
[Interior Decorating](#)
[Landscaping](#)
[Miniatures](#)
[Model Railroading](#)

Also Recommended

[Apply to become a partner for this site.](#)

Magazine Offer

[Click Here](#)

Advertising

[HotJobs](#)

Onward! Upward!

[win millions!!](#)

Just three easy steps can make you a millionaire!

[PrizeCrazy.com](#)

win a Mercedes or \$50,000

[Grolier Books](#)

4 FREE gifts-all new from Scooby-Doo!

Stay up-to-date!
Subscribe to our newsletter.

Want a free web site?
It's easy with new **About
SiteBuilder!**

Get your site now

Want to add search to your
site?

Link to Sprinks - and earn
money!

Become an Affiliate

Got a question?
Ask an Expert

material list for building a Baby Changing Table,
that can also be used as a chest of drawers.

Ball and Bat Rack

HouseNet has a full-sized building diagram and
instructions for a Ball and Bat Rack that is
designed for two bats and three balls.

Barrister Bookcases

Popular Woodworking magazine offers a free
download construction drawing in PDF format
of Barrister Bookcases.

Baseball Cap Rack

Minwax® has this page that has free assembly
diagrams, procedure information, tips, plus a
tools, and materials list in order to make a
Baseball Cap Rack.

Bathroom Vanity

Popular Mechanics has a free project plan,
materials list, plus instructions for a bathroom
vanity that starts on this page.

Bedroom Organizer

Minwax® has this page that has free assembly
diagrams, procedure information, tips, plus a
tools, and materials list in order to make a
Bedroom Organizer.

Bedside Table

Minwax® has this page that has free assembly
diagrams, procedure information, tips, plus a
tools, and materials list in order to make a
Bedside Table.

Bench

California Redwood Association has free plans
and step-by-step instructions for building a
Mendocino Bench.

Birdhouse 1 new

L & R Designs offers a free PDF download plan
to build a traditional 9 1/2" high x 8 1/2" wide x
10" deep birdhouse. All built from 1" x 6"
material.

Birdhouse 2

Johnathon Press Home and Workshop Online has
a free plan and instructions for a family project
for a birdhouse that kids could make.

The Bird Ornament Patterns

WoodCraft Projects has free full scale patterns of
various bird ornaments for a weekend wood/craft
hobbyist. Painting instructions are included.

Blanket Chest 1

August Home Publishing Co. has free plans and
descriptions to build a Country Classic Blanket



Marketplace

- [make great gifts](#)
- [hot pc deals!](#)
- [online casino\\$](#)
- [\\$5 off used music](#)
- [\\$\\$ play lotto \\$\\$](#)
- [need a desktop?](#)
- [tech shopping](#)
- [make cash online](#)
- [get free stuff!](#)
- [oldsmobile](#)
- [gambling @ home](#)

Chest.

Blanket Chest 2

Popular Mechanics has a free project plan, materials list, plus instructions for a blanket chest that starts on this page.

Bluebird House Plans

Here's an article that describes how to build a bluebird house, complete with step by step instructions.

Booklet With Weekend Projects

Minwax® will send you a free Easy Weekend Projects booklet just by simply filling out a request form.

Book/Magazine Stand

Popular Woodworking Magazine offers free instructions, a material list, and a downloadable construction drawing for building a tall book/magazine stand.

Bread Box

Amateur Woodworker offers a free plan and instructions for building a Bread Box. Tools required are a drill, sander, jigsaw, and router.

Build An Office Desk

Popular Mechanics has a free project plan, materials list, plus instructions for a office desk that starts on this page.

Building An Inexpensive Wine Rack

 from About.com

Your About Wine Guide Lisa Shea has very nice colored photos and free instructions for building a wine rack with plywood and PVC pipe.

Bungalow Mailbox

Popular Woodworking magazine offers a free download construction drawing in PDF format of a Bungalow Mailbox.

Byrdcliffe Cabinet

Popular Woodworking magazine offers a free download construction drawing in PDF format of a Byrdcliffe Cabinet.

A Cabinetmaker's Toolchest

Ralph Brendler offers his free basic plans and a description of a toolchest.

CD Carousel new

Freeplans.com™ offers a free detailed plan and instructions for building a CD Carousel that looks like it could hold somewhere around 96 CDs.

CD Holder

Minwax® has this page that has free assembly diagrams, procedure information, tips, plus a tools, and materials list in order to make a CD Holder.

Chattahoochee Chair

Wolmanized® offers this page with material list, and detailed plan.

Classic Winter Sled

Drawings, instructions, material and hardware lists are included on this page to build a Classic Winter Sled that is just under four feet long, and it can be built with common tools.

Coffee Table

Popular Mechanics offers free instructions and photos for building a knock down Coffee Table that looks similar to a trestle table.

Computer Desk

Instructions and a cutting diagram for making a Computer Desk or Study Carrel from a single sheet of plywood.

Computer Desk, and More

Black & Decker has free project instructions, and detailed plans on how-to build an Adirondack Chair, Computer Desk, Indoor Firewood Rack, and an Outdoor Wood Organizer.

Corner Cabinet

Jeff Greef Woodworking supplies detailed instructions and photos for building a small wall mounted Corner Cabinet.

Corner Cupboard

Popular Mechanics offers detailed two part plans, with details on how-to do the case construction, doors, and trim, plus a materials list.

Continue

Free Plans From The Internet D-P

Continue on to a list of more free plans from the internet.

Free Plans From The Internet Q-Z

Continue on to a list of more free plans from the internet.

Free Plans From Your Woodworking Guide

Continue on to another list of links to free plans, drawn up by your Woodworking Guide.

Visit the **Woodworking Forums** to browse as a

guest, or register for free and post.

Bookmark
Woodworking.About.com
Thank You



Subscribe to The Woodworking Newsletter

Name

Email

Just One Click!

Please take a moment and click here.
It will help to keep Woodworking.About.com noticed.
Thank you!

Previous Features

Email this page!

Sponsored Links

Find Books About Woodworking at Half.com

Free \$5 on your first purchase and Get up to 50-90% off everyday! Buy and Sell previously owned Books, CDs, DVDs, Movies and Video Games.

<http://www.half.com/> (Listing fee: \$0.28)

Eagle Creek Custom Etched

Laser engraved and sand carved personalized gifts and awards for animal lovers. Let us transfer your ranch brand, logo, or photo of your special animal onto a lasting "treasure".

<http://www.custom-etched.com/> (Listing fee: \$0.18)

NBAF: Magazine Subscriptions

Best price or we pay you! hundreds of popular magazine subscriptions on every topic and interest.

<http://nbaf.com/> (Listing fee: \$0.09)

NorthernTool

Visit NorthernTool and find power tools, air tools, hand tools, hydraulics, lawn and garden, hunting and handyman products.

<http://www.northerntool-1.com/> (Listing fee: \$0.08)

[StreetFairAmerica.com](http://www.streetfairamerica.com/)

Buy and sell crafts. Free! StreetFairAmerica is the marketplace for crafts, handmade products. Sellers register online. Free setup and no monthly fees. Buyers can browse over 600 handmade items.

<http://www.streetfairamerica.com/> (Listing fee: \$0.06)

[More...](#)

[Buy a Link Now!](#)

ezboard 6.0 **Get a FREE Custom Message Board**
 Talk about:



Explore More on the About Network!

- | | | | |
|--------------------------------------|-----------------------------------|---------------------------------------|---------------------------------------|
| About Australia | Cultures | Internet/Online | Real Estate |
| About Canada | Education | Kids | Religion/Spirituality |
| About India | Food/Drink | Jobs/Careers | Science |
| About Ireland | Finance/Investing | Money | Shopping |
| About UK | Gadgets | Movies | Small Business |
| All About Japan | Games | Music/Performing Arts | Sports |
| Arts/Literature | Health/Fitness | News/Issues | Style |
| Autos | Hobbies | Parenting/Family | Teens |
| Cities/Towns | Home/Garden | People/Relationships | Travel |
| Comedy | Homework Help | Pets | TV/Radio |
| Computing/Technology | Industry | Recreation/Outdoors | |

[About Us](#) | [User Agreement](#) | [Privacy & Kids' Privacy Policy](#) | [Help](#)

Copyright © 2001 About.com, Inc. About and About.com are registered trademarks of About.com, Inc. The About logo is a trademark of About.com, Inc. All rights reserved.



August Home Publishing Company

Oops! We've made some changes in our web page addresses.
Looks like you've got a link to an "old" address.

Please find the page you're looking for by clicking on one of the links below. And then bookmark the new page. **Thanks.**



Woodsmith

[Subscription Info](#)

ShopNotes

[Cutting Diagrams](#)

[Subscription Info](#)

WORKBENCH

[Cutting Diagrams](#)

[Subscription Info](#)

[WB Interactive](#)

WoodNet

[Woodworking Forums](#)

[Weekly E-mail Tips](#)

[101+ Tips & Techniques](#)

[Tool Reviews](#)

[WoodworkingTips.com](#)

[WorkbenchPlans.com](#)

GardenGate

[GardenGateTours.com](#)

[Weekly E-Tips](#)

[Basics](#)

[Design](#)

[Projects](#)

[Plants](#)

[Gardening Forums](#)

[Subscription Info](#)

Cuisine^{at home.}

[CuisineCam.com](#)

[Weekly E-Recipes](#)

[Cooking Forums](#)

[Recipes](#)

[Cooking Tips](#)

[Subscription Info](#)

Our Ecommerce Stores





[August Home Tours](#)

[Woodsmith Tours](#)

[Garden Gate Tours](#)

[Cuisine Travel](#)

[Home](#) | [About August Home Publishing](#) | [Woodsmith Retail Store](#)
[Job Opportunities](#) | [Advertise on this Site](#) | [Contact Us](#)

© August Home Publishing Company
All Rights Reserved.



- Back to the Topic Site
- Turn off this top frame

- > [House](#)
- > [Get Crafty](#)
- > [Decorate](#)

- [Back to the Topic Site](#)
- [Turn off this top frame](#)



Amateur Woodworker

Baby Changing Table

Baby changing tables are a wonderful - yet expensive - addition to any nursery. With that in mind we set about building a baby changing table that would provide a strong combination of practicality and price. The resulting table has subsequently been "battle-tested" for the past month and has stood up to the demands of both mother and



Even better, when your baby (finally) outgrows the need for diapers, the changing table can be used as a children's chest of drawers. Note that the baby changing table does not have a rail around the top. Instead, it is designed to accommodate one of the standard curved foam changing pads.

Construction

Tools required: router, drill, sander

Wood required: pine and plywood

| Description | Qty | Width | Thickness | Length |
|-----------------------------|-----|--------|-----------|---------|
| Front frame | | | | |
| Small verticals | 2 | 2 1/4" | 3/4" | 32" |
| Long verticals | 2 | 2 1/4" | 3/4" | 35 1/2" |
| Top/Middle long horizontals | 3 | 2 1/4" | 3/4" | 30 1/2" |
| Base plank | 1 | 2 1/4" | 3/4" | 47" |

- [Home](#)
- [Archive](#)
- [Finishes](#)
- [Joints](#)
- [Tool Glossary](#)
- [Wood Types](#)
- [Games](#)
- [About AW](#)
- [Contact AW](#)

| | | | | |
|-------------------------------|---|---------|------|---------|
| Top/Middle short horizontals | 2 | 2 1/4" | 3/4" | 14" |
| Rear Frame | | | | |
| Small verticals | 2 | 2 1/4" | 3/4" | 32" |
| Long verticals | 2 | 2 1/4" | 3/4" | 35 1/2" |
| Top long horizontals | 1 | 2 1/4" | 3/4" | 30 1/2" |
| Base plank | 1 | 2 1/4" | 3/4" | 47" |
| Top short horizontal | 1 | 2 1/4" | 3/4" | 14" |
| Side panel (small) | | | | |
| Verticals | 2 | 2 1/4" | 3/4" | 32" |
| Top/bottom | 2 | 2 1/4" | 3/4" | 16 1/2" |
| Side panel (large) | | | | |
| Verticals | 2 | 2 1/4" | 3/4" | 35 1/2" |
| Top/bottom | 2 | 2 1/4" | 3/4" | 16 1/2" |
| Middle panel (plywood) | | | | |
| | 1 | 16 1/2" | 1/2" | 4" |
| Tops | | | | |
| Large (plywood) | 1 | 19 1/2" | 1/2" | 34 1/4" |
| Small (plywood) | 1 | 19 1/2" | 1/2" | 18 1/2" |
| Edging (large top) | 1 | 3/4" | 1/8" | 55" |
| Edging (small top) | 1 | 3/4" | 1/8" | 60" |
| Molding (large top) | 1 | 3/4" | 3/4" | 55" |
| Molding (small top) | 1 | 3/4" | 3/4" | 60" |
| Base board | | | | |
| Front | 1 | 3" | 3/4" | 51" |
| Side | 2 | 3" | 3/4" | 19" |
| Large drawers | | | | |
| Sides | 6 | 5 1/2" | 3/4" | 16 1/2" |
| Inner Front/back | 6 | 5 1/2" | 3/4" | 26" |
| Front | 3 | 9" | 3/4" | 30 1/2" |
| Knobs | 6 | | | |

| Narrow drawers | | | | |
|------------------------------|---|-----|------|---------|
| Sides | 4 | 10" | 3/4" | 16 1/2" |
| Inner Front/back | 4 | 10" | 3/4" | 9 3/4" |
| Front | 2 | 14" | 3/4" | 16 1/2" |
| Knobs | 2 | | | |
| Back panels | | | | |
| Large (hardboard/plywood) | 1 | 32" | 1/8" | 32" |
| Small (hardboard/plywood) | 1 | 16" | 1/8" | 35 1/2" |

1. Prepare front frame pieces (left side)

Firstly, cut lap joints that are 1 1/2" in from each end into the two top pieces (long and short), the middle drawer pieces (two long, one short) and the base plank. Next, cut a slot out of the base plank 13" from the right and 29 1/2" from the left (hence, 4 1/2" wide). Note that when deciding which end is the right and left of this plank, lie the plank flat on the ground with the cut out lap joint part facing upwards (see diagram).

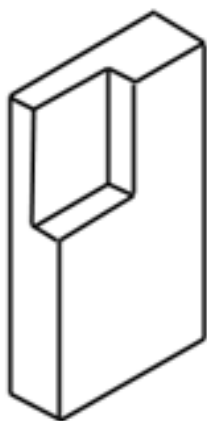
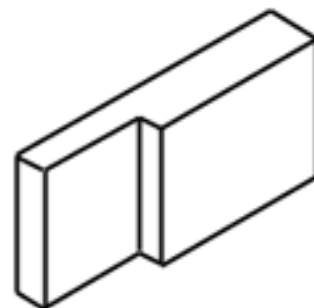

- 29 3/4" to top

Now that all of the horizontal pieces are prepared, we need to prepare the vertical planks. Firstly, take one of the two shorter vertical pieces and nominate it as the left vertical. Cut out grooves that are 3/8" deep and 1 1/2" in (matching the cut on the horizontal pieces) at the following positions from the bottom:

- Bottom to 2 1/4" high
- 10 3/4" to 13"
- 20 1/2" to 22 3/4"

Next, take the second small vertical and nominate it as the middle-right vertical. Make a mirror image of the above grooves in this piece, so that the horizontal planks will slot in. The one difference is that the base to 2 1/4" high cut should be made as a lap joint (i.e. all the way across the wood, rather than just 1 1/2" in) in order to slot into the middle groove cut out of the base plank.

2. Prepare front frame pieces (left side)

Now take one of the two longer vertical planks and nominate it as the right vertical. Cut out grooves that are $\frac{3}{8}$ " deep and $1\frac{1}{2}$ " in (matching the cut on the horizontal pieces) at the following positions from the bottom:

- Bottom to $2\frac{1}{4}$ " high
- $17\frac{1}{2}$ " to $19\frac{3}{4}$ "
- $33\frac{1}{4}$ " to top

Next, take the second long vertical and nominate it as the middle-left vertical. Make a mirror image of the above grooves in this piece, so that the horizontal planks will slot in. The one difference is that the base-to- $2\frac{1}{4}$ " high cut should be made as a lap joint (i.e. all the way across the wood, rather than just $1\frac{1}{2}$ " in) in order to slot into the middle groove cut out of the base plank.

Finally, take the middle-right and taller middle-left planks and glue them together, side by side. To make this joint use either dowel joints or biscuits. The result should be a double width piece that has one side taller than the other. Note that when looking at this piece from the front, it should look like one solid piece - the grooves should be in the back, not the front.

3. Glue front frame together

Once the middle, double plank has dried, it is time to connect the rest of the front together. Glue and screw the pieces together, ensuring that the finished frame is square. To help build a solid frame, clamp overnight to ensure a strong bond.



4. Prepare back frame

The back frame is relatively simple to construct as it consists only of an outer frame. Repeat step 2, but omit the horizontal planks that define the drawer spaces (but include the inner-left and inner-right vertical planks that are glued together as on the front). One prepared, glue the pieces together (as with the front). Again, ensure that the frame is square.

5. Build left (small) side panel

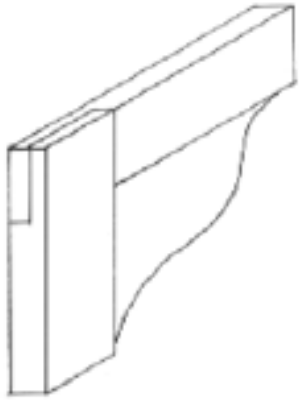

Take the two vertical side pieces and cut lap joints into them, and matching lap joints in the two small horizontal pieces. By so doing, the four pieces should fit together into a rectangular frame (see diagram). Next, rout out a groove on the inner, back edge of all four pieces. This groove should cut in 1/2" and be 1/2" deep. By making this groove all the way around the inside edge, the plywood sheet that forms the side panel can rest in place. Once routed, glue and screw the four side planks together - making sure the joints are square - and then glue the plywood panel into place

in the center (which will help strengthen the unit).

6. Build right (larger) side frame

Repeat step 5 for the right hand panel. Remember that this panel is larger due to the fact that the right side of the front frame is also taller.

7. Build main frame

Now that the two sides, front and back have been built, it is time to put them together. Sandwich the left hand side panel between the front and back panels and screw the three pieces together by driving screws through the front frame into the side as well as from the back frame into the side panel. Then attach the right hand panel to complete the frame. Make sure that the completed frame is square.

8. Add middle panel

Next, add the small middle panel, gluing and screwing it into place. This panel should fill the small void at the point where the front/back steps up from the lower height to the taller level. At this time you should also add a small strengthening bar to the bottom middle of the frame, running from front to back. To add it, glue and screw into place from the front and back.

9. Add tops

The final strengthening trick is adding to table tops. First add the larger, lower top. This should overhang the front and left hand side by 1", over-hanging the back by 1/2". To attach this top, glue and nail - or screw - down into the frame.

Add the smaller top to the higher part of the table next. Again, the overhang should be 1" to the front and both sides.

10. Add edging strip and molding to top

Add the edging strip to front and sides of both tops. Use glue and small finishing nails to hold the strip into place against the plywood edge of the table top. Next, add the small molding to the meeting point between the top and the main frame, thus making the two look more like one unit.

11. Make base panel and attach to base.



To finish off the main unit we need to add a base board that will serve as feet. This is one solid plank that runs the entire length of the unit. Route a curve out of the top side to round it off (see diagram). Add to front and sides - using a mitered cut at each end - using screws and glue. The board should overlap 1" with the frame, providing adequate bonding space.

12. Make drawers

Take the two side pieces, the back and the inner front piece. Cut a groove in each one that is 1/4" from the bottom of each piece and is 1/4" wide. This groove will allow the base to slot into the drawer frame. Once you have cut the groove, glue and screw the sides to the back piece, slot the base into the groove and then glue and screw the inner front board. Make sure that the unit is square. The result is a box without a lid.

Attach a 16" drawer runner mechanism to each side of the drawer, and to the corresponding "hole" in the main unit of the chest. Ensure that all drawer mechanisms are attached at the same height, so that the drawers are interchangeable in the unit. To attach the runners to the main frame, you may need to add a strip of wood to the rear verticals.

Finally, you need to add the front of the drawer to the box unit. However, before doing this, you need to shape the front of the drawer. The edge of this should be rounded using the same router bit as you used for the edging around the bottom of the main unit. Once you have routed all four sides of the drawer front, attach it to the drawer unit by gluing and screwing from the inside of the drawer outwards.

13. Finishing

Finally, nail the two back panel pieces on to the back of the unit and sand the entire unit thoroughly and paint.

[Go to Top](#)

Joints

This section describes in detail all of the joints used in current and past projects. As projects require new methods of joining wood, this section will be expanded. If anyone has any suggestions for this section, please feel free to [email](#) them in. Any suitable contributions will be added to this section, with a credit to the original author.

[Home](#)[Archive](#)[Finishes](#)[Joints](#)[Tool Glossary](#)[Wood Types](#)[Games](#)[About AW](#)[Contact AW](#)[Dowel Joints](#)[Slotted Tenon Joints](#)[Routed Dovetail Joints](#)[Handmade Dovetail Joints](#)[Tenon and Mortise Joints](#)

About[®]
Featured Link

- Back to the Topic Site
- Turn off this top frame



SUBSCRIBE NOW

HOME

Today's News

Updated every 20 minutes:

[Click Here](#)



[PM HOME PAGE](#)

[AUTOMOTIVE](#)

[TECHNOLOGY](#)

[HOME JOURNAL](#)

[SCIENCE](#)

[OUTDOORS](#)

[SEARCH](#)

[WHAT'S HOT](#)

[CURRENT ISSUE](#)

[EMAIL](#)

[ADVERTISE](#)

Special Offer!

Get your **FREE** gift!



CLICK HERE!
for details

GET IT NOW!
click here!



Smooth Transition



The Dryerbox is a small idea, but a good one. Very good, in fact. It's made of 22-gauge aluminized steel, drawn deep into a pan shape. It's sized to fit between wall studs, and it provides a nice clean cavity that receives the exhaust from a dryer. The device makes for a neater installation, a smoother transition from the hose to the back of the dryer, and it allows the dryer to be positioned without fear of kinking the exhaust hose. It's about time somebody came up with a piece of hardware to solve all these problems.

[CLICK FOR MORE >](#)

[click here for](#)
THE LATEST NEWS
From the PM Zone

Editor: Steve Willson
Online Editor: Roy Berendsohn

SPECIALS



Tune in for team **coverage** of our annual Editor's Choice Awards and every square inch of show floor.



From walk-behind **mowers** to heavy-duty tillers and snowthrowers, you'll find it here. [Pull start.](#)



Woodworking

- [Gentle Art Of Whittling Comes Back](#)
- [Create This Mahogany Writing Table](#)
- [How To Build PM's Easy Workbench](#)
- [Shop Project: Cedar Privacy Screen](#)
- [Build Your Own Boat From PM Plans](#)

Gardening

- [5 New Yardcare Machines By Sears](#)
- [Book: 'Classic John Deere Tractors'](#)
- [Long-Term Test: Deere X585 Tractor](#)
- [We Test A ProMow 501 Gang Mower](#)
- [PM.Zone Summer Lawncare Section](#)

Great Stuff

- [The Best Products For Your Home](#)

Home Improvement

- [Neaten Dryer Installation w/Dryerbox](#)
- [Research For Clopay Garage Doors](#)
- [Nat'l Hardware Show Wrapup Report](#)
- [Nat'l Hardware Show Editor's Choice](#)
- [19 Best Of The Inter'l Builders' Show](#)

Homeowners Clinic

- [Aug. Lead: Fixing A Busted Sprinkler](#)
- [July Lead: To Get Rid Of House Mold](#)
- [June Lead: Condensation Drain Fix](#)
- [May Lead: Unequal-Pitch Roof Vents](#)
- [Mar. Lead: Water Pressure Too Low](#)

It Worked For Me

- [Reader Tips And Hints June Column](#)
- [Reader Tips And Hints: May Column](#)
- [Reader Tips And Hints: April Column](#)
- [Reader Tips And Hints: Mar. Column](#)
- [Reader Tips And Hints: Feb. Column](#)

Opinion

- [Our 2 Cents On A Variety Of Subjects](#)

Smart Consumer

- [Unique Oxo Angled Measuring Cup](#)
- [Thompson's Deck Spruce-Up Guide](#)
- [7 High-Featured Kitchen Appliances](#)
- [Fluorescent Bulbs Vs. Incandescent](#)
- [Loctite's Super Glue Gels And Liquid](#)

Tools

- [Magnetic-Backed SilverBack Gloves](#)
- [Leatherman 20th Anniversary Wave](#)
- [A Milwaukee Heavy-Duty Sabre Saw](#)
- [Vaughan & Bushnell Mini-Bear Saws](#)
- [Sears's 2003-04 Craftsman Catalog](#)

Workshop

- [Miller Electric Welding Equip. Advice](#)
- [Better Ryobi BT3100 Benchtop Saw](#)
- [Comparo: Six Stationary Scroll Saws](#)
- [A Steelman Portable Welding Bench](#)
- [Basics Of Home-Shop Metalworking](#)

This is your one-stop depot for more than 1000 portable and stationary products from more than 2 dozen manufacturers. You can search and sort by category, manufacturer, price range and model number. Here's the [power button](#).

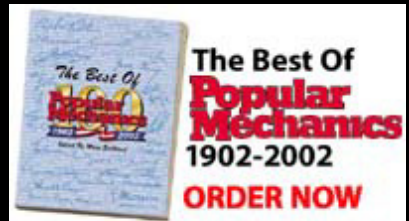

NEW LOWER PRICE

And here's a **Free Poster Offer**.



Have any good tips, quick fixes or tricks of the trade that you'd like to share? Send them to: It Worked For Me, c/o POPULAR MECHANICS, 810 Seventh Ave., New York, NY 10019. Or e-mail us at pmtips@hearst.com.



If you're planning to buy your first new home-- or the first one in a long time--here's how to get your bearings before heading out the door. And just [look at all the closet space](#).



SUBSCRIBE NOW

HOME

click here for THE LATEST NEWS From the PM Zone

Homeowners Clinic

Monthly Reader Q & A Column

BY NORMAN BECKER, P.E.

[PRINTER FRIENDLY VERSION](#)

[1](#) [2](#) [3](#) [Next](#)

Questions About Mold

I have heard many reports of mold in houses in the Houston area. What is mold and how can I prevent it from occurring in my house?

YOUNG NGUYEN
ADDRESS WITHHELD

Mold is the common name for simple plants or fungi that are usually microscopically small. There are many varieties--some estimates put the number at a minimum of 40,000. These plants thrive on cotton, wool, paper, leather and wood, and they will grow anywhere in the home where there is moisture. The moisture may be in the material itself or in the form of airborne vapor. A typical mold is the one found in the grouted tile joints of shower walls.

Most mold spores found in homes do not present a serious health problem. However, people who have mold allergies could experience symptoms such as nasal stuffiness, eye irritation and difficulty breathing.

In the mold-related incidents you are referring to, severe moisture problems in a number of houses led to a comparatively



[CLICK TO ENLARGE](#)

Mold can grow anywhere in a house--in the attic, basement and crawlspaces, on interior and exterior surfaces, and in wall cavities. The best method to combat it is to keep surfaces and interior spaces dry. ILLUSTRATION BY GEORGE RETSECK

- [PM HOME PAGE](#)
- [AUTOMOTIVE](#)
- [TECHNOLOGY](#)
- [HOME JOURNAL](#)
- [SCIENCE](#)
- [OUTDOORS](#)
- [SEARCH](#)
- [WHAT'S HOT](#)
- [CURRENT ISSUE](#)
- [EMAIL](#)
- [ADVERTISE](#)

Special Offer!

Get your **FREE gift!**



[CLICK HERE!](#)
for details

GET IT NOW!
click here!

rare mold condition--that is, a concentration of the mold species called Stachybotrys chartarum. The family living in one home suffered a number of severe health-related problems.

There isn't room here to present a complete discussion of mold, but the drawing above gives an overview of the parts of your house that require careful inspection and maintenance. Pay particular attention to the roof and to chimney flashing to be sure that neither is admitting water. Likewise, leaks around doors and windows can admit water as can cracks in a basement floor. Condensation on windows, leaking plumbing and moisture vapor from a crawlspace are other sources that can cause mold to form. The best way to control mold is to keep building surfaces and cavities as dry as possible.

[1](#) [2](#) [3](#) [Next](#)

 RELATED ARTICLES

PRINTER FRIENDLY VERSION



SUBSCRIBE NOW

HOME

click here for
THE LATEST NEWS
From the PM Zone

Homeowners Clinic

Monthly Reader Q & A Column

PRINTER FRIENDLY VERSION

[Previous](#) [1](#) [2](#) [3](#) [Next](#)

Smoke Alarm Signal

My husband and I were awakened recently when all our hard-wired smoke detectors went off at once. We checked everything and found no problem. Do you have any idea what causes this?

AMANDA COLE
VIA INTERNET

A smoke alarm can be triggered by a buildup of dust, dirt or an insect building a nest inside it. To prevent this, gently vacuum a smoke alarm periodically, and change its battery once a year. When smoke alarms are hard-wired and one unit is activated, all the others will be activated. The fact that the alarms went off at the same time indicates that they are working properly.

Special Offer!

Get your **FREE gift!**



CLICK HERE!
for details

GET IT NOW!
click here!

Step-By-Step Range Repair Manual

- For GE and Hotpoint ranges
- Easy to follow instructions
- Step-by-step photos
- Diagnostic charts
- Preventive maintenance



CLICK TO ENLARGE

REVIEW: Appliance Repair Help

The most important tool is information, and when it comes to appliance repair, that may mean getting a service manual, such as the one shown here. Your best one-stop source for manuals, parts and information is RepairClinic.com. It carries a wide selection of current appliance repair manuals for General Electric and Whirlpool products, as well as some for Sears Kenmore. It's also

the best full-service appliance part source we know of. The company says that on any given day it has 90 percent of the parts requested, with 600,000 parts available through online ordering. And it has industry contacts to find stuff that is out-of-date. Simply put, before you give up, contact this company. Finally, if you need help with the repair itself, the company's technicians offer advice via e-mail. Contact RepairClinic.com, 47440 Michigan Ave., Suite 100, Canton, MI 48188; 800-269-2609. Or go to the company's Web site: www.repairclinic.com.--
Roy Berendsohn

[Previous](#) [1](#) [2](#) [3](#) [Next](#)

 **RELATED ARTICLES**

PRINTER FRIENDLY VERSION



SUBSCRIBE NOW

HOME

click here for
THE LATEST NEWS
 From the PM Zone

Homeowners Clinic

Monthly Reader Q & A Column

PRINTER FRIENDLY VERSION

[Previous](#) [1](#) [2](#) [3](#)

Horizontal Water Heater

Can the average upright water heater be installed horizontally as a spacesaving measure?

BILL AKERMAN
 VIA INTERNET

No. An electric water heater is designed for upright installation. Even shipping one in a horizontal position can damage it. The heater's anode and the water inlet pipe are not supported. Placing the water heater horizontally can cause the pipe or the anode to flex against the tank's vitreous glass lining, damaging it.

Also, a horizontal installation would not be energy efficient. In an upright installation, the water inlet pipe terminates near the bottom of the tank. As the water is heated, it rises to the top of the tank where it is drawn off at the hot-water outlet. A horizontal installation would put the inlet and the outlet in the same plane and cause cold and hot water to be mixed.

Special Offer!

Get your **FREE gift!**



CLICK HERE!
for details

GET IT NOW!
click here!



Do You Have A Home-Maintenance Or Repair Problem?

Just ask Norman about it. Send your questions to Homeowners Clinic, POPULAR MECHANICS, 810 Seventh Ave., New York, NY 10019. While letters cannot be answered individually, problems of general interest will be discussed in the column.

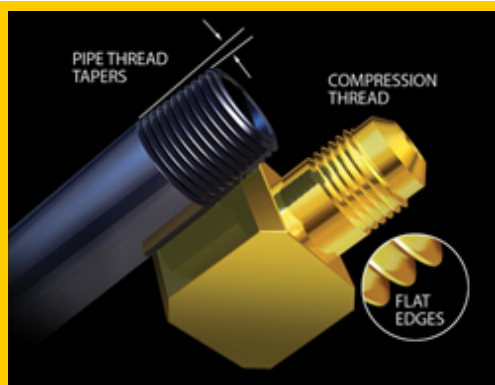

[CLICK TO ENLARGE](#)

SERVICE TIP: MAINTENANCE

Gas Appliance Safety

Illustration by George Retseck

When you bring a new gas dryer or range home, or move a gas appliance to a new location, there are several things to be aware of so that the installation is troublefree and safe. First, the most important piece of advice is a general one, and that is to make the connection from the appliance to the gas supply using some form of flexible connector. This will allow movement of the appliance without the risk of breaking the seal on gastight connections, an obvious fire hazard.

Second, if you've never worked with pipe before, have a plumber or an appliance technician do the installation to be sure that it is gastight. If you have experience working with pipe, there are still several things to be mindful of :

1. When joining threaded fittings, be sure to make connections with compatible threads. Iron pipe thread is wedge-shaped and tapered. It will not make a gastight connection when joined to a flare-compression thread. For example, to make the connection to a dryer's black iron pipe nipple, you have to use a fitting that has a female iron pipe thread on one end and a compression thread on the other.
2. When working on black iron pipe, use

Teflon tape or pipe thread sealant that is certified for gas fittings. On flare-compression fittings, use thread sealant only. Be sure the sealant is rated for natural gas or propane, or both. Tape for working with gas fittings is yellow and is thicker than the white tape used for sealing water plumbing. Both the pipe thread sealant and the tape are clearly labeled as approved for gas connections.

3. In many cases, the entire job can be simplified with a dryer or range connection kit. This consists of a flexible connector, a variety of fittings, Teflon tape, leak-test solution, and instructions. These kits cost \$20 to \$25.

4. If you find that an existing gas appliance (in most cases, a range) is joined to the house's gas supply with a connector made from bare corrugated brass tubing, be sure to replace it. The Consumer Product Safety Commission (CPSC) has issued a warning that this kind of connector has tubing that separates from its fittings. Visit the CPSC Web site for more information at www.cpsc.gov/cpscpub/pubs/gasconn.html.

Finally, be sure not to overtighten flare-compression fittings. A snug fit is all that is required to provide a gastight seal. When you're done, leak test all connections using a solution of dish detergent and water, or use ready-made leak-test solution.--*R.B.*

[Previous](#) [1](#) [2](#) [3](#)

 RELATED ARTICLES

PRINTER FRIENDLY VERSION



SUBSCRIBE NOW

HOME

click here for
THE LATEST NEWS
From the PM Zone

Home Improvement

Best Of The Builders' Show

19 new tools and building materials.

BY ROY BERENDSOHN

PRINTER FRIENDLY VERSION

1 [2](#) [3](#) [4](#) [5](#) [Next](#)

PM HOME PAGE

AUTOMOTIVE

TECHNOLOGY

HOME JOURNAL

SCIENCE

OUTDOORS

SEARCH

WHAT'S HOT

CURRENT ISSUE

EMAIL

ADVERTISE

Special Offer!

Get your **FREE gift!**



CLICK HERE!
for details

GET IT NOW!
click here!



[Click here](#) for our original online report from Las Vegas in January.

- [Steel-Cutting Circular Saw](#)
- [Internet Refrigerator](#)
- [Finish Nailer Kit](#)
- [Colonial Casement Window](#)
- [Cordless Planer](#)
- [Masonry Water Repellent](#)
- [Lighted Sabre Saw](#)
- [Adjustable-Height Sawhorse](#)
- [Indoor-Outdoor Fireplace](#)
- [Traditional-Looking Wood Window](#)

- [Water-Based Floor Enamel](#)
- [Cordless Impact Driver](#)
- [Solar Roof Vent](#)
- [Compact Water Softener](#)
- [Washer-Dryer Pair](#)
- [Double-Hung Window](#)
- [Cast-Iron Sinks](#)

There's nothing like the International Builders' Show. We attended the event recently in Las Vegas and looked over the offerings of 1300 manufacturers who brought 300 separate product categories to show. They spread it all out over 1.2 million sq. ft. of floor space. Although luxury products abound--from state-of-the-art stainless steel appliances to luxury spas--it's still at its heart a show for people who drive a pickup to an open space and build a place to live. That's what it's all about--tools, sawdust, concrete, fixtures, building wire, pipe and tubing. And sweat. Here's the best stuff from the show.

[1](#) [2](#) [3](#) [4](#) [5](#) [Next](#)

 RELATED ARTICLES

PRINTER FRIENDLY VERSION



Woodworking

with [Lew Soloway](#)

Your Guide to one of [hundreds of sites](#)

This page sponsored by



[Home](#) · [Articles](#) · [Forums](#) · [Chat](#) · [Newsletters](#) · [Help](#)

Subjects

In The Spotlight

ESSENTIALS

• [About Woodworking](#)

[Glossary](#)

• [A Beginner's Hand](#)

[Tools List](#)

• [How to Prepare](#)

[Lumber for Projects](#)

• [How to Choose](#)

[Sandpaper - Part 1](#)

• [How to Choose](#)

[Sandpaper - Part 2](#)

[Dust Collection](#)

[Events](#)

[Finishing](#)

[Furniture Styles](#)

[Glossaries](#)

[Hand Tools](#)

[Joinery](#)

[Lumber](#)

[Old Tools](#)

[Project Design](#)

[Project Plans](#)

[Power Tools](#)

[Product Reviews](#)

[Sharpening](#)

[Shop Safety](#)

[Training](#)

[Woodcarving](#)

[Woodturning](#)

[Sources-Finishing](#)

[How to Choose the Right Sandpaper - Part 1](#)

This is Part 1 in a two-part series on the five things to consider when buying sandpaper for your woodworking and finishing projects. This part covers types of abrasives used in sandpaper and grit sizes. Part 2 addresses binders, backing material, and optional adherence materials.

[Read Archives](#) #

[How to Choose the Right Sandpaper - Part 2](#)

This is Part 2 in a two-part series on the five things to consider when buying sandpaper for your woodworking and finishing projects. This part covers binders, backing material, and optional adherence materials. Part 1 addresses types of abrasives used in sandpaper and grit sizes.

[Read Archives](#) #

[How to Prepare Lumber for Your Woodworking Projects](#)

Your guide takes you through the eight steps on how to prepare lumber for your next woodworking project. Whether you buy lumber rough or surfaced from the mill, the lumber yard, a home center, or a specialty wood store you have to prepare the lumber for use.

[Read Archives](#) #

[Planning for Wood Expansion and Contraction](#)

Wood expands and shrinks. Your guide discusses why wood moves, provides a formula for calculating the movement, and points out where wood movement can be an important consideration in your project design.

[Read Archives](#) #

[A Hand Tools List for the Beginner](#)

Every woodworker needs hand tools. Here's a list of tools for the

- [Sources-General](#)
- [Sources-Hand Tools](#)
- [Sources-Power Tool](#)
- [Sources-Sharpening](#)

[Subject Library](#)

[All articles on this topic](#)

woodworker just starting out. This list is by no means exhaustive - its only meant to be a guide. A future article will include an extended list for the more experienced woodworker.

[Read Archives](#) #

[The Types of Files and Rasps Used in Woodworking](#)

Your guide discusses the basic types of files and rasps used in woodworking. The difference between files and rasps is explained. Then the purpose of each type of file and rasp is discussed.

[Read Archives](#) #

[Subscribe Now](#)



[Display Latest Headlines](#) [XML](#) | [Read Archives](#)

powered by [Movable Type](#)

[Email this page!](#)

Sponsored Links

[Epilog Laser Wood Engraving and Cutting Systems](#)

Epilog Laser's are ideal for engraving and cutting woods, plastic, acrylic, trophies, plaques and photos. Systems start under \$15,000. Visit our website for more information and free samples.

<http://www.epiloglaser.com/> [Sponsored Link](#)

[Woodworking Superstore - Rockler.com](#)

Find everything you need for furniture building, cabinet making and more. Tools, hardware, plans, and woodworking supplies. Rockler Woodworking and Hardware, Since 1954!

<http://www.rockler.com/> [Sponsored Link](#)

[Cumberland Woodcraft Decorative Woodwork](#)

Cumberland Woodcraft offers an extensive line of decorative woodwork from corbels, brackets, carvings, appliques and molding to cabinetry and paneling for home decorating.

<http://www.cumberlandwoodcraft.com/> [Sponsored Link](#)

[Discounted Decorative & Tole Painting Books](#)

Buy your favorite Decorative & Tole Painting Books at 20% off. MyIdeaCenter has a large selection of books from various artists and publisher. Orders shipped priority mail for quick delivery to you.

<http://store.yahoo.com/> [Sponsored Link](#)

[Enhance - Organize - Share Photos](#)

Paint Shop Photo Album is your complete digital photography center, with everything from a one-click Quick Fix to powerful organizational features to VideoCD creation with photos and music.

<http://www.jasc.com/> [Sponsored Link](#)

Stay up-to-date!
Subscribe to our newsletter.

ResultsAbout
New from About.com!

Get Paid to Improve Search

Find Results Now:

- [Crafts](#)
- [Log Homes](#)
- [Cliff Notes](#)
- [Death](#)
- [Quotes](#)

Advertising

> [Free Credit Report](#)

[Buy a Link Now!](#)**FREE TRIAL ISSUE Of Crafts Magazine!**

Get your FREE trial issue of *Crafts Magazine* and receive 7 more issues for ONLY \$17.97 -- **that's a 54% savings!** We'll bill you later.

Fill out the form and get great ideas to help reveal your creative genius. Just complete the information below and click on submit. **Order now!**

Trial Issue![Give a gift!](#)**ORDER NOW!**

Email:

First Name:

Last Name:

Address Line 1:

Address Line 2:

City:

State:

Zip:

Select a payment option: Charge my credit card

Bill me later

Brought to you by **WHAT YOU NEED TO KNOW About**

Explore More on the About Network!**Related Sites**

[Architecture](#)
[Forestry](#)
[Home Repair](#)
[Interior Decorating](#)
[Landscaping](#)

Walk More

Walking Guide
 Wendy Bumgardner says it only takes 2,000 more steps a day to start losing weight.

Quake Coming?

Is it possible for people to predict earth quakes?
 Geology Guide
 Andrew Alden offers his insights.

The Guru

There are 23 million Sikhs in the world.
 Alternative Religions Guide
 Jennifer Emick has more.

Search About

[About Us](#) | [Advertise on This Site](#) | [User Agreement](#) | [Privacy Policy](#) | [Kids' Privacy Policy](#) | [Help](#)

Copyright © 2003 About, Inc. About and About.com are registered trademarks of About, Inc. The About logo is a trademark of About, Inc. All rights reserved.



Landscaping

with [David Beaulieu](#)

Your Guide to one of [hundreds of sites](#)

[Home](#) · [Articles](#) · [Forums](#) · [Chat](#) · [Newsletters](#) · [Help](#)

Subjects

ESSENTIALS

- [Landscaping Glossary](#)
- [Landscape Solutions](#)
- [Landscaping 101](#)
- [Landscape Design for Beginners](#)
- [Landscaping FAQs](#)

BUYER'S GUIDE

[Landscape Design](#)
[Ornamental Trees](#)
[Fall Foliage Trees](#)
[Shrub Fall Colors](#)
[Cheap Landscaping](#)
[Easy Landscaping](#)
[Landscape Plans](#)
[Rock Gardens](#)
[Patios, Walls](#)
[Design for Birds](#)
[Garden Pests](#)
[Weed Control](#)
[Bonsai, Japanese](#)
[Shrubs, Bushes](#)
[Decks and Arbors](#)
[Links](#)

In The Spotlight

[An Inlay Design for Concrete Patio Floors](#)

Using concrete as a surface for patios is practical -- too practical, for some. To spice up bare concrete with home accents, incorporate inlay designs. This article details many concrete patio designs, including the planning required to implement such designs successfully for your new patio or landing.

[Thursday September 18, 2003](#) #

Wildflower Identification: Name That Wildflower!

Landscaping enthusiasts and nature-lovers often

take
great
pride
in
being
able
to
identify
plants
on



and around their landscapes. Here's your chance to test your knowledge! See if you know the wildflower pictured on your right. To verify that you've arrived at the correct answer, please read my follow-up in the [Landscaping Discussion Forum](#), where I've revealed the wildflower's name. This entry is the 4th in a series of wildflower identifications.

[Hedges, Fences](#)

[Compost and Mulch](#)

[Fruit Trees](#)

[Ground Cover Vines](#)

[Garden Accents](#)

[Houseplants](#)

[Pond, Water Garden](#)

[Software, Hire Pro](#)

[Soil, Fertilizer](#)

[Rose Bushes](#)

[Lawn Care](#)

[Year-round Color](#)

[Gift Ideas](#)

[Top Picks](#)

[Subject Library](#)

[All articles on this topic](#)

Stay up-to-date!

Subscribe to our newsletter.

ResultsAbout

New from About.com!

[Get Paid to Improve Search](#)

Find Results Now:

[Feng Shui](#)

[Rolling Stones](#)

[Atkins Diet](#)

[Elvis Presley](#)

[Log Homes](#)

Hint: The photo to your right has been used elsewhere on this Web site, in a story on poison ivy.

[Thursday September 18, 2003](#) #

Mulch to Consider

Mulch is mulch, isn't it? It's just something to spread around beneath plants, to suppress weeds, right? Wrong. There's much to consider when choosing between mulches for your landscaping and gardening needs. Learn about some of those considerations here.

[Wednesday September 17, 2003](#) #

Garden Railroading: Mobile Landscape Design

"Garden railroading is the art of combining a model railroad and a beautiful garden to create a railway-like atmosphere," says the Garden Railways Magazine Web site. Read the rest of their [Brief Overview of Garden Railways](#) to find out what it is that makes this fast-growing landscaping technique so popular.

[Wednesday September 17, 2003](#) #

Top 10 Shrubs and Vines for Fall Foliage

Trees don't hold a monopoly over providing attractive fall foliage. Shrubs and vines can be used to complement the fall foliage produced by the trees in your landscaping. Consider the choices presented here.

[Tuesday September 16, 2003](#) #

Landscape Design Ideas: Building Berms

Landscaping berms are mounds of dirt that are often erected to add visual interest to the landscape. This [article on building berms](#) from the Home and Garden Television Web site offers ideas on incorporating

Did You Know?

Edgar Allan Poe, master of the macabre, was instrumental in the development both of the detective story and science fiction. But this eclectic genius also penned some compelling landscape design ideas

[Edgar Allan Poe and Landscape Design](#)

berms into a Japanese-garden landscape design.

[Tuesday September 16, 2003 #](#)

[Sumac Trees for Fall Foliage](#)

Sumac trees are sometimes despised as being little better than weeds. But fall foliage lovers know better! Sumac trees put on one of the landscape's showiest fall foliage displays. And as if its foliage weren't colorful enough in fall, it also bears an attractive red seed tuft throughout the autumn season. Eighth in a series of articles on fall foliage trees, all of which can be accessed from the [fall foliage index](#). In addition to their fall display, the sumacs have an interesting story to tell....

[Monday September 15, 2003 #](#)

Advertising

> [Free Credit Report](#)

Online Resources for Landscape Design Ideas

Are you looking for ideas to design that "master plan" for your landscape? This [landscape design link](#) provides online resources that will allow you to explore everything from conducting soil tests to planting according to plant hardiness zones.

[Monday September 15, 2003 #](#)

Hurricane Preparedness: Readyng the Yard for Isabel

Hurricanes can bring costly damage to yards and homes. As we watch Isabel's progress, let's look at a checklist of 10 reminders for hurricane preparedness for the yard. The items on this hurricane preparedness checklist run the gamut in terms of ease of implementation. Most are just reminders to take simple precautions. But one involves a landscaping project of some difficulty for do-it-yourselfers. And another may require you to enlist the services of professionals.

[Sunday September 14, 2003 #](#)

Build a Bat House for Mosquito Control

In this [Plant Man column](#) Steve Jones talks about attracting wildlife to the landscape. Not surprisingly, he touches on installing birdhouses. You may be a bit surprised to hear him speak of *butterfly houses*. But here's what may really catch you off guard: Steve talks about installing houses for *bats* to keep the mosquito population under control.

[Sunday September 14, 2003](#) #

[Display Latest Headlines](#) [XML](#) | [Read Archives](#)

powered by [Movable Type](#)

[Email this page!](#)

Sponsored Links

[Distinctive Wild Bird and Garden Wildlife Products](#)

GardenBirds.com specializes in distinctive bird houses, bird feeders, bird baths and other products for garden wildlife. We have a free shipping offer and your satisfaction is guaranteed.

<http://www.GardenBirds.com/> [Sponsored Link](#)

[InsideSun Discount Garden Supplies](#)

InsideSun is your one-stop-shop for growing needs. Complete 400w HPS system only \$90. Huge discounts on MH too. Light systems and bulbs, hydroponics, nutrients, CO2, carbon scrubbers and more!

<http://www.insidesun.com/> [Sponsored Link](#)

[Home Harvest Garden Supply](#)

Fertilizers, compost, soil, discount seeds, greenhouses, nursery supplies, pest controls, pots, propagation, hydroponics, season extenders, grow lights and lots more at Home Harvest Garden Supply!

<http://homeharvest.com/> [Sponsored Link](#)

[Keep Your Home Safe - ADT](#)

Help protect your family and your home. Free security systems and free security reviews. Install a home security system from your local ADT

Authorized Dealer. Find out more.

<http://www.keepyourhomesafe.com> [Sponsored Link](#)

[Home and Garden shopping at FurnitureFind.com!](#)

Browse a large selection of home and garden furnishings. Find quality, name brand furniture, save 30-50% and get free delivery! Call us today to take advantage of our free personal shopper service.

<http://www.furniturefind.com/> [Sponsored Link](#)

[Buy a Link Now!](#)

Explore More on the About Network!

| | | | | |
|---|--|---|---|----------------------------|
| <p>Related Sites</p> <p><u>Architecture</u> <u>Birding/Wild Birds</u> <u>Gardening</u> <u>Home Repair</u></p> | <p><u>Large Rats</u></p> <p>Exotic Pets Guide Lianne McLeod introduces you to the 30-inch long Gambian Giant Rat.</p> | <p><u>Decision 2004</u></p> <p>With Wesley Clark officially in the race, U.S. Politics Guide Anne Linskey looks at all the candidates.</p> | <p><u>Malcolm X</u></p> <p>African-American History Guide Jessica McElrath tells us about the life of Malcolm X.</p> | <p>Search About</p> |
|---|--|---|---|----------------------------|

[About Us](#) | [Advertise on This Site](#) | [User Agreement](#) | [Privacy Policy](#) | [Kids' Privacy Policy](#) | [Help](#)

Copyright © [2003](#) About, Inc. About and About.com are registered trademarks of About, Inc. The About logo is a trademark of About, Inc. All rights reserved.



Landscaping

with [David Beaulieu](#)

Your Guide to one of [hundreds of sites](#)

[Home](#) · [Articles](#) · [Forums](#) · [Chat](#) · [Newsletters](#) · [Help](#)

Subjects

ESSENTIALS

- [Landscaping Glossary](#)
- [Landscape Solutions](#)
- [Landscaping 101](#)
- [Landscape Design for Beginners](#)
- [Landscaping FAQs](#)

BUYER'S GUIDE

[Landscape Design](#)

[Ornamental Trees](#)

[Fall Foliage Trees](#)

[Shrub Fall Colors](#)

[Cheap Landscaping](#)

[Easy Landscaping](#)

[Landscape Plans](#)

[Rock Gardens](#)

[Patios, Walls](#)

[Design for Birds](#)

[Garden Pests](#)

[Weed Control](#)

[Bonsai, Japanese](#)

[Shrubs, Bushes](#)

[Decks and Arbors](#)

[Links](#)

Landscape Design Ideas - Garden Photos

Guide picks

Pictures and explanations of garden and landscape design ideas. Let these free ideas from landscapers inspire your new garden or landscape design. Landscaping can increase the real estate value of your property by 15%. Why not mine this free source for pictures and information to work home improvement wonders in your backyard?

[Landscaping Pictures: A Landscape Design Photo Gallery](#)

Need some ideas for your landscaping? Browse through the pictures in this landscape design photo gallery. Analyses accompany the images. Some of the landscape design samples covered are arbors, fences, focal points, hillside landscaping, and making use of the concept of "line" to guide the viewer's eye to where you want it to go.

[Free Landscape Design Plan That is Deer-Proof, Tick-Proof](#)

Free landscaping plan to promote beauty and health on your borders! Deer are garden pests, but deer ticks are worse than pests -- they're downright dangerous. To minimize infestation of these Lyme disease-bearers, follow a deer-resistant border design. This free landscape design plan is supplemented by pictures and descriptions of plants

[Hedges, Fences](#)

[Compost and Mulch](#)

[Fruit Trees](#)

[Ground Cover Vines](#)

[Garden Accents](#)

[Houseplants](#)

[Pond, Water Garden](#)

[Software, Hire Pro](#)

[Soil, Fertilizer](#)

[Rose Bushes](#)

[Lawn Care](#)

[Year-round Color](#)

[Gift Ideas](#)

[Top Picks](#)

[Subject Library](#)

[All articles on this topic](#)

Stay up-to-date!

Subscribe to our newsletter.

ResultsAbout

New from About.com!

[Get Paid to Improve Search](#)

Find Results Now:

[Feng Shui](#)

[Rolling Stones](#)

[Atkins Diet](#)

[Elvis Presley](#)

[Log Homes](#)

suitable for a deer-proof border.

[Landscape Design Ideas for Selling Your Property](#)

When you're designing a landscape that will be going on the real estate market, you're designing for someone else's tastes -- the buyer's -- not your own. You need ideas about what buyers are currently looking for. You'll get those design ideas in this article, plus advice on exploiting other sources for design ideas.

[Landscape Design Theory for Beginners](#)

Outdoor aesthetics 101. A practical introduction to the principles of landscape design architecture, as well as the basic elements upon which they are grounded. Starting point for backyard makeovers. Unity (harmony), colors, focalization, perspectives, textures, forms, massing, repetitions, balance, symmetry.

[History of Landscape Design: Two Schools of Thought](#)

Learn about the historical development of the two major schools of landscape design: formal and informal. Do it yourselfers planning major outside home improvement projects will profit from clarifying their own stance on this debate.

[What is Landscape Design?](#)

Definition of landscape design for the do it yourselfer. Hardscape and softscape themes discussed, both from practical and aesthetic standpoints. Garden types, lawn space and principles of design outlined. Practical considerations covered include hiring arborists and tailoring a landscape for the real estate market.

[History of Landscape Design](#)

Advertising

> [Free Credit Report](#)

A short history of landscape design, from your About.com Landscaping guide. From the Roman Pliny to the American Olmsted, see how landscape design has evolved. Learn what distinguishes "formal landscape design" from the informal, more "natural" style. This article is helpful for those laying the groundwork for a makeover of their own landscapes.

Edgar Allan Poe and Landscape Design

Edgar Allan Poe, master of the macabre, was instrumental in the development both of the detective story and science fiction. But this eclectic genius also penned some compelling ideas on the subject of landscape design. Read about the landscape design at Arnheim, as well as the reason why its designer undertook the project.

Product Review: Landscaping Book by Better Homes and Gardens

Your About.com Landscaping Guide's review of a design book by Better Homes and Gardens. "Home Landscaping: Plants, Projects, and Ideas for Your Yard" is a great gift idea for gardeners. Purchase a gift for them that will give them something to get through the winter months -- planning next year's landscape design. Smart consumer's choice for the money.

The Basic Principles of Landscape Design

Part of a comprehensive Web site dedicated to landscape design, this article lays out the basics of designing a landscape. Learn about the landscape design concepts of unity, balance, color, transition, line, proportion and repetition.

1 [2](#) [Next](#)



[Email this page!](#)

Sponsored Links

[Be the first Sponsored Links advertiser on this site...](#)

Start driving targeted traffic to your site with Sprinks, About's Sponsored Links program.

<http://sprinks.about.com/>

[Buy a Link Now!](#)

Explore More on the About Network!

| | | | | |
|---|--|---|---|----------------------------|
| <p>Related Sites</p> <p><u>Architecture</u> <u>Birding/Wild Birds</u> <u>Gardening</u> <u>Home Repair</u></p> | <p><u>Large Rats</u></p> <p>Exotic Pets Guide Lianne McLeod introduces you to the 30-inch long Gambian Giant Rat.</p> | <p><u>Decision 2004</u></p> <p>With Wesley Clark officially in the race, U.S. Politics Guide Anne Linskey looks at all the candidates.</p> | <p><u>Malcolm X</u></p> <p>African-American History Guide Jessica McElrath tells us about the life of Malcolm X.</p> | <p>Search About</p> |
|---|--|---|---|----------------------------|

[About Us](#) | [Advertise on This Site](#) | [User Agreement](#) | [Privacy Policy](#) | [Kids' Privacy Policy](#) | [Help](#)

Copyright © 2003 About, Inc. About and About.com are registered trademarks of About, Inc. The About logo is a trademark of About, Inc. All rights reserved.



Landscaping

with [David Beaulieu](#)

Your Guide to one of [hundreds of sites](#)

[Home](#) · [Articles](#) · [Forums](#) · [Chat](#) · [Newsletters](#) · [Help](#)

Subjects

ESSENTIALS

- [Landscaping Glossary](#)
- [Landscape Solutions](#)
- [Landscaping 101](#)
- [Landscape Design for Beginners](#)
- [Landscaping FAQs](#)

BUYER'S GUIDE

- [Landscape Design](#)
- [Ornamental Trees](#)
- [Fall Foliage Trees](#)
- [Shrub Fall Colors](#)
- [Cheap Landscaping](#)
- [Easy Landscaping](#)
- [Landscape Plans](#)
- [Rock Gardens](#)
- [Patios, Walls](#)
- [Design for Birds](#)
- [Garden Pests](#)
- [Weed Control](#)
- [Bonsai, Japanese](#)
- [Shrubs, Bushes](#)
- [Decks and Arbors](#)
- [Links](#)

Landscaping Pictures: Photo Gallery

Photos of Landscape Design Ideas

A picture is worth a thousand words. Sometimes you can get ideas for landscaping projects by looking at other people's landscape designs. Let the landscaping pictures in this photo gallery inspire you in your DIY landscaping projects!

Click on any of the thumbnails in the photo gallery below to view the full-size version of the image.

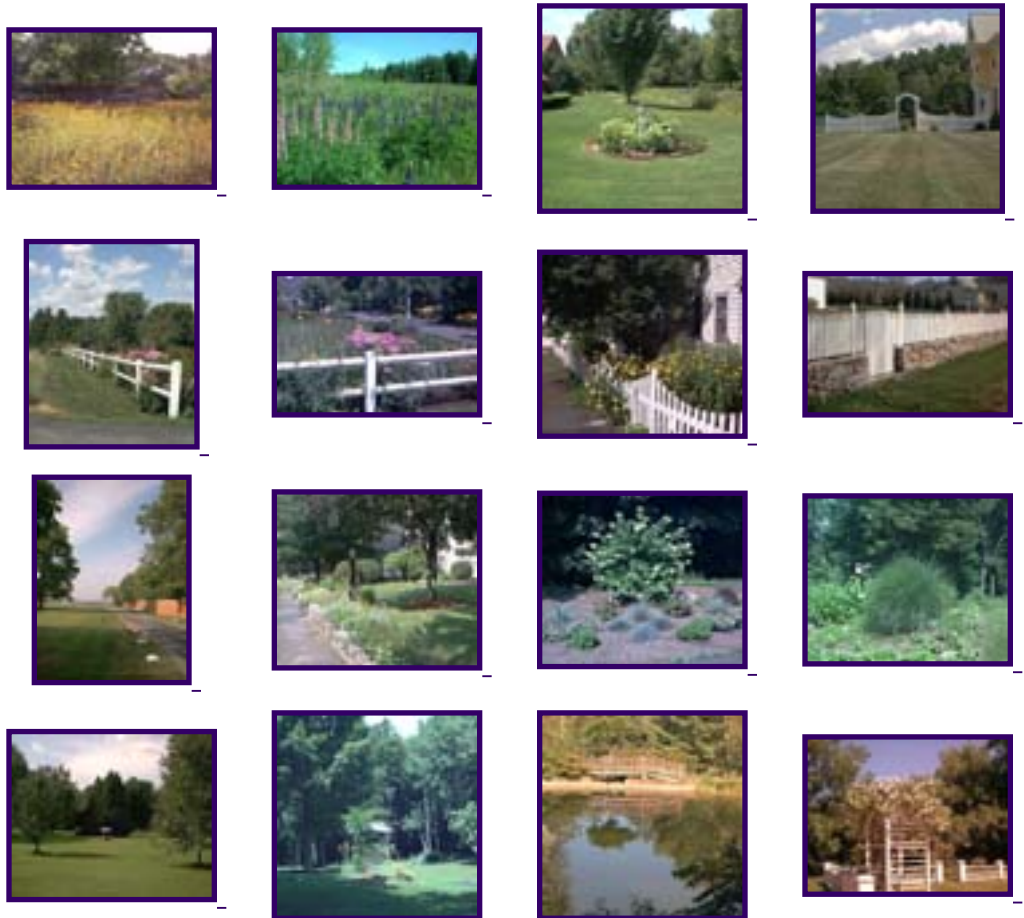

[Hedges, Fences](#)

[Compost and Mulch](#)

[Fruit Trees](#)

[Ground Cover Vines](#)

[Garden Accents](#)

[Houseplants](#)

[Pond, Water Garden](#)

[Software, Hire Pro](#)

[Soil, Fertilizer](#)

[Rose Bushes](#)

[Lawn Care](#)

[Year-round Color](#)

[Gift Ideas](#)

[Top Picks](#)

[Subject Library](#)

[All articles on this topic](#)

Stay up-to-date!
Subscribe to our newsletter.

ResultsAbout

New from About.com!

[Get Paid to Improve Search](#)

Find Results Now:

[Feng Shui](#)

[Rolling Stones](#)

[Atkins Diet](#)

[Elvis Presley](#)

[Log Homes](#)

-- David Beaulieu

[Previous Articles](#)

[Email this page!](#)

Sponsored Links

[Distinctive Wild Bird and Garden Wildlife Products](#)

GardenBirds.com specializes in distinctive bird houses, bird feeders, bird baths and other products for garden wildlife. We have a free shipping offer and your satisfaction is guaranteed.

<http://www.GardenBirds.com/> [Sponsored Link](#)

[InsideSun Discount Garden Supplies](#)

InsideSun is your one-stop-shop for growing needs. Complete 400w HPS system only \$90. Huge discounts on MH too. Light systems and bulbs, hydroponics, nutrients, CO2, carbon scrubbers and more!

<http://www.insidesun.com/> [Sponsored Link](#)

[Home Harvest Garden Supply](#)

Fertilizers, compost, soil, discount seeds, greenhouses, nursery supplies, pest controls, pots, propagation, hydroponics, season extenders, grow lights and lots more at Home Harvest Garden Supply!

<http://homeharvest.com/> [Sponsored Link](#)

[Keep Your Home Safe - ADT](#)

Help protect your family and your home. Free security systems and free security reviews. Install a home security system from your local ADT Authorized Dealer. Find out more.

<http://www.Keepyourhomesafe.com> [Sponsored Link](#)

[Home and Garden shopping at FurnitureFind.com!](#)

Browse a large selection of home and garden furnishings. Find quality, name brand furniture, save 30-50% and get free delivery! Call us today to take advantage of our free personal shopper service.

<http://www.furniturefind.com/> [Sponsored Link](#)

[Buy a Link Now!](#)

Advertising

> [Free Credit Report](#)

Explore More on the About Network!

| | | | | |
|--|--|--|--|---------------------|
| Related Sites Architecture Birding/Wild Birds Gardening Home Repair | Large Rats Exotic Pets Guide Lianne McLeod introduces you to the 30- inch long Gambian Giant Rat. | Decision 2004 With Wesley Clark officially in the race, U.S. Politics Guide Anne Linskey looks at all the candidates. | Malcolm X African- American History Guide Jessica McElrath tells us about the life of Malcolm X. | Search About |
|--|--|--|--|---------------------|

[About Us](#) | [Advertise on This Site](#) | [User Agreement](#) | [Privacy Policy](#) | [Kids' Privacy Policy](#) | [Help](#)

Copyright © 2003 About, Inc. About and About.com are registered trademarks of About, Inc. The About logo is a trademark of About, Inc. All rights reserved.



Landscaping

with [David Beaulieu](#)

Your Guide to one of [hundreds of sites](#)

[Home](#) · [Articles](#) · [Forums](#) · [Chat](#) · [Newsletters](#) · [Help](#)

Subjects

ESSENTIALS

- [Landscaping Glossary](#)
- [Landscape Solutions](#)
- [Landscaping 101](#)
- [Landscape Design for Beginners](#)
- [Landscaping FAQs](#)

BUYER'S GUIDE

[Landscape Design](#)

[Ornamental Trees](#)

[Fall Foliage Trees](#)

[Shrub Fall Colors](#)

[Cheap Landscaping](#)

[Easy Landscaping](#)

[Landscape Plans](#)

[Rock Gardens](#)

[Patios, Walls](#)

[Design for Birds](#)

[Garden Pests](#)

[Weed Control](#)

[Bonsai, Japanese](#)

[Shrubs, Bushes](#)

[Decks and Arbors](#)

[Links](#)

Landscape Design Ideas for Beginners

Part 1: Principles of Landscape Design Explained, With Pictures



Photo by David Beaulieu

This picture illustrates "texture," specifically the textural contrast between zinnia and cosmos.

"Landscape design theory." Sounds rather imposing, doesn't it? And, to be sure, one could spend years studying all the ideas in the field of landscape design. But what if you simply need to give your lawn and gardens a makeover? If you need to spruce up the landscape design of a house that you are about to sell, or if you simply want to enjoy an enhanced design for your home's lawn and gardens, you could profit

More of this Feature

- [Part 2: Basic Landscape Design Ideas](#)
- [Part 3: Principles of Landscape Design Theory](#)

Related Resources

- [Planning Your Gardens: What is Landscape Design?](#)
- [Home Landscape Design Ideas](#)
- [Landscape Design FAQs](#)

[Hedges, Fences](#)
[Compost and Mulch](#)
[Fruit Trees](#)
[Ground Cover Vines](#)
[Garden Accents](#)
[Houseplants](#)
[Pond, Water Garden](#)
[Software, Hire Pro](#)
[Soil, Fertilizer](#)
[Rose Bushes](#)
[Lawn Care](#)
[Year-round Color](#)
[Gift Ideas](#)
[Top Picks](#)

[Subject Library](#)

[All articles on this topic](#)

Stay up-to-date!

Subscribe to our newsletter.

Results About

New from
About.com!

[Get Paid to Improve Search](#)

Find Results Now:

[Feng Shui](#)
[Rolling Stones](#)
[Atkins Diet](#)
[Elvis Presley](#)
[Log Homes](#)

from a straightforward, no-nonsense look at the ideas behind landscape design theory, supplemented with pictures.

Whenever you put something together yourself, you are engaged in **designing**, however humble the project. Sometimes we take our designs for granted, because what we're putting together is so commonplace for us that we are no longer conscious of the designing process. For instance, you are employing design techniques when you compose a letter to send to somebody. Your basic design "elements" to accomplish such a task include vocabulary, spelling and grammar. Somewhat more complex elements, or design "principles" build directly on the basic elements. Letter-writing principles include conveying your ideas clearly and coming across as a courteous, intelligent individual. Your success with these principles will largely determine whether or not your letter achieves its ultimate objective.

And so it is with landscape design theory. First you must learn the basic design elements that underlie all landscape design theory. These fundamental elements will then serve as building blocks for learning and implementing the more advanced principles of landscape design theory. These tried and true principles are the cornerstones of the world's picture-perfect gardens.

The basic elements of landscape design theory are:

- Color
- [Form](#) (see picture on Page 2)
- [Line](#) (see picture on Page 3)
- Scale
- [Texture](#) (see picture above)

These five elements must be considered in designing both the [hardscape](#) and [softscape](#) of a landscape, the latter consisting mainly of gardens, lawns, shrubs and trees. While **color** is self-explanatory (for our purposes), and **scale** is simply the size of one component relative to adjacent components, the other three elements require some explanation. What can make these terms confusing is the fact that their meanings intertwine with each other, as we'll see on [Page 2](#)....

Next page > [Defining Form, Line and Texture in Landscape Design Theory](#) > [Page 1](#), [2](#), [3](#)

Elsewhere on the Web

- [Landscape Design Ideas](#)
- [Landscape Design Theory According to Olmsted](#)

Advertising

> [Free Credit Report](#)

[Email this page!](#)

Sponsored Links

[Distinctive Wild Bird and Garden Wildlife Products](#)

GardenBirds.com specializes in distinctive bird houses, bird feeders, bird baths and other products for garden wildlife. We have a free shipping offer and your satisfaction is guaranteed.

<http://www.GardenBirds.com/> [Sponsored Link](#)

[InsideSun Discount Garden Supplies](#)

InsideSun is your one-stop-shop for growing needs. Complete 400w HPS system only \$90. Huge discounts on MH too. Light systems and bulbs, hydroponics, nutrients, CO2, carbon scrubbers and more!

<http://www.insidesun.com/> [Sponsored Link](#)

[Home Harvest Garden Supply](#)

Fertilizers, compost, soil, discount seeds, greenhouses, nursery supplies, pest controls, pots, propagation, hydroponics, season extenders, grow lights and lots more at Home Harvest Garden Supply!

<http://homeharvest.com/> [Sponsored Link](#)

[Keep Your Home Safe - ADT](#)

Help protect your family and your home. Free security systems and free security reviews. Install a home security system from your local ADT Authorized Dealer. Find out more.

<http://www.keepyourhomesafe.com> [Sponsored Link](#)

[Home and Garden shopping at FurnitureFind.com!](#)

Browse a large selection of home and garden furnishings. Find quality, name brand furniture, save 30-50% and get free delivery! Call us today to take advantage of our free personal shopper service.

<http://www.furniturefind.com/> [Sponsored Link](#)

[Buy a Link Now!](#)

Explore More on the About Network!

| | | | | |
|--|---|--|---|---------------------|
| Related Sites Architecture Birding/Wild Birds Gardening Home Repair | <u>Large Rats</u> Exotic Pets Guide Lianne McLeod introduces you to the 30- inch long Gambian Giant Rat. | <u>Decision</u> <u>2004</u> With Wesley Clark officially in the race, U.S. Politics Guide Anne Linskey looks at all the candidates. | <u>Malcolm X</u> African- American History Guide Jessica McElrath tells us about the life of Malcolm X. | Search About |
|--|---|--|---|---------------------|

[About Us](#) | [Advertise on This Site](#) | [User Agreement](#) | [Privacy Policy](#) | [Kids' Privacy Policy](#) | [Help](#)

Copyright © [2003](#) About, Inc. About and About.com are registered trademarks of About, Inc. The About logo is a trademark of About, Inc. All rights reserved.



Landscaping

with [David Beaulieu](#)

Your Guide to one of [hundreds of sites](#)

[Home](#) · [Articles](#) · [Forums](#) · [Chat](#) · [Newsletters](#) · [Help](#)

Subjects

ESSENTIALS

- [Landscaping Glossary](#)
- [Landscape Solutions](#)
- [Landscaping 101](#)
- [Landscape Design for Beginners](#)
- [Landscaping FAQs](#)

BUYER'S GUIDE

[Landscape Design](#)

[Ornamental Trees](#)

[Fall Foliage Trees](#)

[Shrub Fall Colors](#)

[Cheap Landscaping](#)

[Easy Landscaping](#)

[Landscape Plans](#)

[Rock Gardens](#)

[Patios, Walls](#)

[Design for Birds](#)

[Garden Pests](#)

[Weed Control](#)

[Bonsai, Japanese](#)

[Shrubs, Bushes](#)

[Decks and Arbors](#)

[Links](#)

form

< [Back to Last Page](#) > < [Full Glossary](#) >

Definition: (landscape design terminology) The shape of a plant, e.g., upright, oval, columnar, spreading, broad spreading, or weeping.

Related Terms

- [landscape design](#)

< [Back to Last Page](#) > < [Full Glossary](#) >

Email this page!

Sponsored Links

[Distinctive Wild Bird and Garden Wildlife Products](#)

GardenBirds.com specializes in distinctive bird houses, bird feeders, bird baths and other products for garden wildlife. We have a free shipping offer and your satisfaction is guaranteed.

<http://www.GardenBirds.com/> [Sponsored Link](#)

[InsideSun Discount Garden Supplies](#)

InsideSun is your one-stop-shop for growing needs. Complete 400w HPS system only \$90. Huge discounts on MH too. Light systems and bulbs, hydroponics, nutrients, CO2, carbon scrubbers and more!

<http://www.insidesun.com/> [Sponsored Link](#)

[Home Harvest Garden Supply](#)

Fertilizers, compost, soil, discount seeds, greenhouses, nursery supplies, pest controls, pots, propagation, hydroponics, season extenders, grow lights and lots more at Home Harvest Garden Supply!

<http://homeharvest.com/> [Sponsored Link](#)

[Keep Your Home Safe - ADT](#)

Help protect your family and your home. Free security systems and free

[Hedges, Fences](#)

[Compost and Mulch](#)

[Fruit Trees](#)

[Ground Cover Vines](#)

[Garden Accents](#)

[Houseplants](#)

[Pond, Water Garden](#)

[Software, Hire Pro](#)

[Soil, Fertilizer](#)

[Rose Bushes](#)

[Lawn Care](#)

[Year-round Color](#)

[Gift Ideas](#)

[Top Picks](#)

[Subject Library](#)

[All articles on this
topic](#)

security reviews. Install a home security system from your local ADT Authorized Dealer. Find out more.

<http://www.keepyourhomesafe.com> [Sponsored Link](#)

[Home and Garden shopping at FurnitureFind.com!](#)

Browse a large selection of home and garden furnishings. Find quality, name brand furniture, save 30-50% and get free delivery! Call us today to take advantage of our free personal shopper service.

<http://www.furniturefind.com/> [Sponsored Link](#)

[Buy a Link Now!](#)

Stay up-to-date!

Subscribe to our
newsletter.

ResultsAbout

**New from
About.com!**

[Get Paid to Improve Search](#)

Find Results Now:

[Feng Shui](#)

[Rolling Stones](#)

[Atkins Diet](#)

[Elvis Presley](#)

[Log Homes](#)

Advertising

> [Free Credit Report](#)

Explore More on the About Network!

| | | | | |
|--|--|--|--|---------------------|
| Related Sites Architecture Birding/Wild Birds Gardening Home Repair | Large Rats Exotic Pets Guide Lianne McLeod introduces you to the 30- inch long Gambian Giant Rat. | Decision 2004 With Wesley Clark officially in the race, U.S. Politics Guide Anne Linskey looks at all the candidates. | Malcolm X African- American History Guide Jessica McElrath tells us about the life of Malcolm X. | Search About |
|--|--|--|--|---------------------|

[About Us](#) | [Advertise on This Site](#) | [User Agreement](#) | [Privacy Policy](#) | [Kids' Privacy Policy](#) | [Help](#)

Copyright © 2003 About, Inc. About and About.com are registered trademarks of About, Inc. The About logo is a trademark of About, Inc. All rights reserved.



Landscaping

with [David Beaulieu](#)

Your Guide to one of [hundreds of sites](#)

[Home](#) · [Articles](#) · [Forums](#) · [Chat](#) · [Newsletters](#) · [Help](#)

Subjects

ESSENTIALS

- [Landscaping Glossary](#)
- [Landscape Solutions](#)
- [Landscaping 101](#)
- [Landscape Design for Beginners](#)
- [Landscaping FAQs](#)

BUYER'S GUIDE

[Landscape Design](#)

[Ornamental Trees](#)

[Fall Foliage Trees](#)

[Shrub Fall Colors](#)

[Cheap Landscaping](#)

[Easy Landscaping](#)

[Landscape Plans](#)

[Rock Gardens](#)

[Patios, Walls](#)

[Design for Birds](#)

[Garden Pests](#)

[Weed Control](#)

[Bonsai, Japanese](#)

[Shrubs, Bushes](#)

[Decks and Arbors](#)

[Links](#)

Frugal Landscaping for Cheapskates

Guide picks

Resources for the budget landscaper committed to frugal living, alias tightwads and cheapskates. These resources are dedicated to the proposition that ingenuity can create a landscape that looks like a million bucks. Learn how the drought-tolerant plants used in xeriscaping save money on irrigation, and how lawn alternatives save can save money on poisons, fertilizer and mowing.

Saving Money Through Prevention: Hurricane Preparedness **New**

A checklist of ten reminders for hurricane preparedness. Hurricane damage can be costly to your yards and homes. Reduce the costs of potential hurricane damage through prevention. Some of these tips are simple reminders; others involve more complex projects that need to be planned well in advance of stormy weather.

How to Build a Cheap Garden Arbor: Free Plans

A garden arbor can serve as a landscaping focal point. Learn how to build an easy, cheap do it yourself garden arbor with the tips provided here. Article includes a free garden arbor plan. Learn about shopping for cheaper prices on lumber. Fine living and frugal living: they are not mutually exclusive!

[Hedges, Fences](#)

[Compost and Mulch](#)

[Fruit Trees](#)

[Ground Cover Vines](#)

[Garden Accents](#)

[Houseplants](#)

[Pond, Water Garden](#)

[Software, Hire Pro](#)

[Soil, Fertilizer](#)

[Rose Bushes](#)

[Lawn Care](#)

[Year-round Color](#)

[Gift Ideas](#)

[Top Picks](#)

[Subject Library](#)

[All articles on this topic](#)

Stay up-to-date!

Subscribe to our newsletter.

ResultsAbout

New from About.com!

Get Paid to Improve Search

Find Results Now:

[Feng Shui](#)

[Rolling Stones](#)

[Atkins Diet](#)

[Elvis Presley](#)

[Log Homes](#)

[Frugal Water Gardens With Do-It-Yourself](#)

[Water Fountains](#)

Ideas for cheap water gardens. Buy a low-cost statue at a salvage goods yard, and turn it into a homemade water fountain. This do-it-yourself project will make your garden the envy of all frugal living connoisseurs. Add in some free decorative rocks and end up with a fountain that *looks* anything but cheap!

[Clover Lawns: Frugal Living Alternative to Grass](#)

What do clover lawns have over grass lawns? How about drought-tolerance, low-maintenance, cost-savings and environmental safety? Interested? Clover is insect-resistant and competes well with weeds, eliminating need for insecticides and herbicides. Raking, mowing and other lawn care is also reduced with clover. Have a green lawn all summer without losing "green" out of your wallet.

[Attractive Landscaping for Free With Pussy Willows](#)

Great idea for cheap landscaping: Pussy willows are easy to grow in gardens, and they're free! Discover their botany, easy incorporation into the landscape or garden, and minimal pruning requirements. Pussy willows are an inexpensive landscaping alternative to store-bought shrubs.

[Xeriscape: The Cheap Landscape Alternative](#)

As drought becomes a reality in North America, xeriscaping presents itself as a landscape alternative. The price tag on the extra watering required for turf grass is by no means a "cheapskate's delight." It may be time to look into a cheaper landscape alternative -- the xeriscape.

[A Hypertufa How-To](#)

Advertising

> [Free Credit Report](#)

Deborah Simpson's article on avoiding the cost of "hypertufa" articles such as stepping stones and birdbaths. A step-by-step approach to making your own, Portland cement, sand and peat moss.

Alternatives to Turf Lawns: Cheaper Landscaping

There are cheaper alternatives to grass lawns for those committed to frugal living. Save money by growing cover crops or clover, instead of costly grass. Perennial flower beds also cut down on lawn expanse and expense. Cheaper also translates into "less work," in this case.

Bella's Tips for Frugal Living

Ideas from Bella Online for saving money while meeting your landscaping needs. Tips ranging from acquiring plants for free to fighting weeds using homemade herbicides.

Do-It-Yourself Landscapers

A story on do-it-yourself landscapers by Victoria Sizemore Long of "The Kansas City Star." Featured is a man who removed an existing fence on his property and replaced it with a new one. Proper landscaping greatly enhances the real estate value of your property.

1 [2](#) [Next](#)

[Email this page!](#)

Sponsored Links

[Distinctive Wild Bird and Garden Wildlife Products](#)

GardenBirds.com specializes in distinctive bird houses, bird feeders, bird baths and other products for garden wildlife. We have a free shipping offer and your satisfaction is guaranteed.

<http://www.GardenBirds.com/> [Sponsored Link](#)

[InsideSun Discount Garden Supplies](#)

InsideSun is your one-stop-shop for growing needs. Complete 400w HPS system only \$90. Huge discounts on MH too. Light systems and bulbs, hydroponics, nutrients, CO2, carbon scrubbers and more!

<http://www.insidesun.com/> [Sponsored Link](#)

[Home Harvest Garden Supply](#)

Fertilizers, compost, soil, discount seeds, greenhouses, nursery supplies, pest controls, pots, propagation, hydroponics, season extenders, grow lights and lots more at Home Harvest Garden Supply!

<http://homeharvest.com/> [Sponsored Link](#)

[Keep Your Home Safe - ADT](#)

Help protect your family and your home. Free security systems and free security reviews. Install a home security system from your local ADT Authorized Dealer. Find out more.

<http://www.KeepYourHomeSafe.com> [Sponsored Link](#)

[Home and Garden shopping at FurnitureFind.com!](#)

Browse a large selection of home and garden furnishings. Find quality, name brand furniture, save 30-50% and get free delivery! Call us today to take advantage of our free personal shopper service.

<http://www.furniturefind.com/> [Sponsored Link](#)

[Buy a Link Now!](#)

Explore More on the About Network!

| | | | | |
|---|---|--|--|----------------------------|
| <p>Related Sites</p> <p>Architecture Birding/Wild Birds Gardening Home Repair</p> | <p>Large Rats</p> <p>Exotic Pets Guide Lianne McLeod introduces you to the 30-inch long Gambian Giant Rat.</p> | <p>Decision</p> <p>2004</p> <p>With Wesley Clark officially in the race, U.S. Politics Guide Anne Linskey looks at all the candidates.</p> | <p>Malcolm X</p> <p>African-American History Guide Jessica McElrath tells us about the life of Malcolm X.</p> | <p>Search About</p> |
|---|---|--|--|----------------------------|

[About Us](#) | [Advertise on This Site](#) | [User Agreement](#) | [Privacy Policy](#) | [Kids' Privacy Policy](#) | [Help](#)

Copyright © 2003 About, Inc. About and About.com are registered trademarks of About, Inc. The About logo is a trademark of About, Inc. All rights reserved.



Landscaping

with [David Beaulieu](#)

Your Guide to one of [hundreds of sites](#)

[Home](#) · [Articles](#) · [Forums](#) · [Chat](#) · [Newsletters](#) · [Help](#)

Subjects

ESSENTIALS

- [Landscaping Glossary](#)
- [Landscape Solutions](#)
- [Landscaping 101](#)
- [Landscape Design for Beginners](#)
- [Landscaping FAQs](#)

BUYER'S GUIDE

[Landscape Design](#)

[Ornamental Trees](#)

[Fall Foliage Trees](#)

[Shrub Fall Colors](#)

[Cheap Landscaping](#)

[Easy Landscaping](#)

[Landscape Plans](#)

[Rock Gardens](#)

[Patios, Walls](#)

[Design for Birds](#)

[Garden Pests](#)

[Weed Control](#)

[Bonsai, Japanese](#)

[Shrubs, Bushes](#)

[Decks and Arbors](#)

[Links](#)

[Hedges, Fences](#)

[Compost and Mulch](#)

[Fruit Trees](#)

[Ground Cover Vines](#)

[Garden Accents](#)

Garden Arbor Design

How to Build Garden Arbors

Building small garden [arbors](#) is an easy do-it-yourself project -- cheap, too, if you're willing to shop around a bit for your pressure-treated lumber. The garden arbor design in this project calls for a 2-post arbor; but you can apply the same principles to a larger wooden arbor. It will take the average do-it-yourself landscaper 2 days to build this garden arbor.

The Basics of the Garden Arbor Design: An Overview

Think of this project as involving five architectural layers:

1. Concrete placed underground will secure the structure.
2. Two 4X4 posts will be sunk into that concrete.
3. Two 1x6 crosspieces will run along the sides of these posts at the very top, perpendicular to them. One

click below for more images



The Garden Arbor
David Beaulieu

[Email to a friend](#)

[Printer friendly version](#)

All Articles on Landscaping

- [Previous Articles](#)

Join the Discussion

- [Solving Drainage Problems](#)

Related Resources

- [How to Build Brick Patios](#)
- [Backyard Water Fountains](#)
- [How to Build Concrete Patios](#)

About Landscaping

Subscribe to the Free Newsletter

Your Email Address:

[Houseplants](#)
[Pond, Water Garden](#)
[Software, Hire Pro](#)
[Soil, Fertilizer](#)
[Rose Bushes](#)
[Lawn Care](#)
[Year-round Color](#)
[Gift Ideas](#)
[Top Picks](#)

[Subject Library](#)

[All articles on this topic](#)

Stay up-to-date!
Subscribe to our newsletter.

ResultsAbout

New from About.com!

[Get Paid to Improve Search](#)

Find Results Now:

[Feng Shui](#)

[Rolling Stones](#)

[Atkins Diet](#)

[Elvis Presley](#)

[Log Homes](#)

Advertising

> [Free Credit Report](#)

crosspiece will be on the outer side, the other on the inner side; thus they will "sandwich" the top 6" of the upright posts.

4. 2x4 rafters, in turn, will lie atop the crosspieces, perpendicular to them.
5. And 2x2s will lie across the rafters, perpendicular to them.

Cost of the Garden Arbor: Shopping Around for Cheap Lumber

The cost of lumber for this garden arbor project depends to some degree on the do-it-yourselfer's willingness to shop around. I went to a discount store to purchase the pressure-treated lumber for my own project. Now, to be sure, a lot of rejects end up in the lumber bins of such a store. I had to sort through about 20 boards on average to find 1 good board. Is it worth the extra work? Well, judge for yourself as you look over the following list of surprisingly cheap prices (all measurements are in feet):

- Five 2x2x8s at \$1.50 each
- Three 2x4x8s at \$2.48 each
- Two 1x6x12s at \$3.88 each

Even after the price for the two 4x4s is added in, the total for lumber came only to about \$30. If your information about building arbors derives from television shows, it may be hard for you to believe at first that the wood for a small arbor can be purchased for around \$30!

Supplies -- The Materials for the Garden Arbor:

- Pressure-treated lumber:
 - Five 2x2x8s
 - Five 2x4x3s
 - Two 1x6x12s (hereafter referred to simply as the "crosspieces")
 - Two 4x4 posts
- Gravel or crushed stone
- Pre-mixed concrete
- Deck screws
- Bolts, washers and nuts
- Scrap lumber

Note:

When I give lumber dimensions here, I am following a convention. Please note that a 4x4 is not really 4" by 4". Sounds odd, I know. But everyone calls them 4x4s, so I'm following that convention. In fact, they measure 3.5" x 3.5". Likewise, the so-called 2x4s are really 1.5" x 3.5".

Tools to Build the Garden Arbor:

- Wheelbarrow
- Garden hose
- Shovel
- Carpenter's level
- Jigsaw
- Circular saw or handsaw
- Drill
- Wood chisel
- Spade bit
- Stepladder
- File
- Tape measure
- Hammer
- Wrench

On this page I've supplemented the overview with photos illustrating steps involved in the building of an arbor. Photo #1 above is a picture of the finished wooden garden arbor. Photo #2, accessed by clicking on the first photo to open up the mini-photo gallery, is a picture illustrating an alignment tip. Photo #3, accessed by clicking on the first photo to open up the mini-photo gallery, is a picture of a design you can cut into your rafter ends.

Step-by-step instructions to begin building an arbor are presented on the following pages, beginning with some concrete work on Page 2 to ensure the sturdiness of your arbor design....

1 | [2](#) | [3](#) | [4](#) | [5](#) | [next](#)

[Email this page!](#)

Sponsored Links

[Distinctive Wild Bird and Garden Wildlife Products](#)

GardenBirds.com specializes in distinctive bird houses, bird feeders, bird baths and other products for garden wildlife. We have a free shipping offer and your satisfaction is guaranteed.

<http://www.GardenBirds.com/> [Sponsored Link](#)

[InsideSun Discount Garden Supplies](#)

InsideSun is your one-stop-shop for growing needs. Complete 400w HPS system only \$90. Huge discounts on MH too. Light systems and bulbs, hydroponics, nutrients, CO2, carbon scrubbers and more!

<http://www.insidesun.com/> [Sponsored Link](#)

[Home Harvest Garden Supply](#)

Fertilizers, compost, soil, discount seeds, greenhouses, nursery supplies, pest controls, pots, propagation, hydroponics, season extenders, grow lights and lots more at Home Harvest Garden Supply!

<http://homeharvest.com/> [Sponsored Link](#)

[Keep Your Home Safe - ADT](#)

Help protect your family and your home. Free security systems and free security reviews. Install a home security system from your local ADT Authorized Dealer. Find out more.

<http://www.keepyourhomesafe.com> [Sponsored Link](#)

[Home and Garden shopping at FurnitureFind.com!](#)

Browse a large selection of home and garden furnishings. Find quality, name brand furniture, save 30-50% and get free delivery! Call us today to take advantage of our free personal shopper service.

<http://www.furniturefind.com/> [Sponsored Link](#)

[Buy a Link Now!](#)

Explore More on the About Network!

| | | | | |
|---|--|---|---|----------------------------|
| <p>Related Sites</p> <p>Architecture Birding/Wild Birds Gardening Home Repair</p> | <p><u>Large Rats</u></p> <p>Exotic Pets Guide Lianne McLeod introduces you to the 30-inch long Gambian Giant Rat.</p> | <p><u>Decision 2004</u></p> <p>With Wesley Clark officially in the race, U.S. Politics Guide Anne Linskey looks at all the candidates.</p> | <p><u>Malcolm X</u></p> <p>African-American History Guide Jessica McElrath tells us about the life of Malcolm X.</p> | <p>Search About</p> |
|---|--|---|---|----------------------------|

[About Us](#) | [Advertise on This Site](#) | [User Agreement](#) | [Privacy Policy](#) | [Kids' Privacy Policy](#) | [Help](#)

Copyright © 2003 About, Inc. About and About.com are registered trademarks of About, Inc. The About logo is a trademark of About, Inc. All rights reserved.



Landscaping

with [David Beaulieu](#)

Your Guide to one of [hundreds of sites](#)

[Home](#) · [Articles](#) · [Forums](#) · [Chat](#) · [Newsletters](#) · [Help](#)

Subjects

ESSENTIALS

- [Landscaping Glossary](#)
- [Landscape Solutions](#)
- [Landscaping 101](#)
- [Landscape Design for Beginners](#)
- [Landscaping FAQs](#)

BUYER'S GUIDE

[Landscape Design](#)

[Ornamental Trees](#)

[Fall Foliage Trees](#)

[Shrub Fall Colors](#)

[Cheap Landscaping](#)

[Easy Landscaping](#)

[Landscape Plans](#)

[Rock Gardens](#)

[Patios, Walls](#)

[Design for Birds](#)

[Garden Pests](#)

[Weed Control](#)

[Bonsai, Japanese](#)

[Shrubs, Bushes](#)

[Decks and Arbors](#)

[Links](#)

[Hedges, Fences](#)

[Compost and Mulch](#)

[Fruit Trees](#)

[Ground Cover Vines](#)

[Garden Accents](#)

Designing and Building Wooden Garden Arbors

page 2

Garden Arbor Steps: Instructions for Building Do-It-Yourself Arbors

On the present page we begin with foundations for garden arbors: digging post holes, plumbing the arbor's posts, and pouring the concrete that will hold them in place.

- Dig 2 holes, spaced as far apart as you want the main posts of your garden arbor to stand (in the project photographed here, the posts stand about 8' apart on center). Make the holes about 1' wide and 3' deep.
- Place about 1/2' of gravel or crushed stone into the holes for drainage.
- Set one 4x4 arbor post in one hole, the other in the other hole.
- Lay a board across the tops of the two arbor posts. Place a carpenter's level on the board. If the board is level, your posts are standing at equal heights -- which is what you want. Otherwise,



Ensuring the posts remain plumb by bracing them with scrap lumber.
David Beaulieu

[✉ Email to a friend](#)

[🖨 Printer friendly version](#)

All Articles on Landscaping

- [Previous Articles](#)

Join the Discussion

- [Solving Drainage Problems](#)

Related Resources

- [How to Build Brick Patios](#)
- [Backyard Water Fountains](#)
- [How to Build Concrete Patios](#)

About Landscaping

Subscribe to the Free Newsletter
Your Email

Address:

[Houseplants](#)

[Pond, Water Garden](#)

[Software, Hire Pro](#)

[Soil, Fertilizer](#)

[Rose Bushes](#)

[Lawn Care](#)

[Year-round Color](#)

[Gift Ideas](#)

[Top Picks](#)

[Subject Library](#)

[All articles on this topic](#)

Stay up-to-date!

Subscribe to our newsletter.

ResultsAbout

New from About.com!

[Get Paid to Improve Search](#)

Find Results Now:

[Feng Shui](#)

[Rolling Stones](#)

[Atkins Diet](#)

[Elvis Presley](#)

[Log Homes](#)

Advertising

> [Free Credit Report](#)

make the necessary adjustment.

- To ensure that the posts will be plumb (i.e., the vertical equivalent to "level"), nail scrap lumber to each of them to form temporary, stabilizing braces (for a picture of such braces, see photo above). With these braces in place, check for plumbness on all sides with a carpenter's level. If the posts aren't exactly plumb, adjust the positioning of the temporary braces, accordingly.

Garden Arbor Tip:

Be careful, when buying your 4x4 posts, to get the height you'll need. Remember, an 8' post sunk 3' into the ground leaves you with an arbor only 5' tall. If you get a deal that you can't pass up on some 8' 4x4 pressure-treated posts, though, it is possible to compensate for their lack of height. Buy galvanized post anchors for each post. Sink the post anchors into the concrete, instead of the posts themselves. The pressure-treated posts would then be attached to these anchors, meaning all 8' would be above ground. Post anchors, however, can be expensive -- make sure that you're not defeating the purpose of getting the lumber at a cheap price!

Securing the Posts With Concrete

- Dump a bag of pre-mixed concrete into a wheelbarrow. Add water from a garden hose. Stir the water into the concrete with a shovel, until achieving the right consistency.
- Pour this concrete into one of the holes, around the base of the post. Repeat until hole is filled; and repeat for other hole.
- Allow this concrete to dry, or "cure" for at least one day.

Garden Arbor Tip:

While waiting, lay out the other boards on the ground, make your measurements, and pre-cut and pre-drill as much as possible, to save time.

With the concrete work done, on Page 3 the focus shifts to carpentry. Since these instructions are meant for non-carpenters, the emphasis will be on the easiest way to accomplish each task....

[Email this page!](#)

Sponsored Links

[Distinctive Wild Bird and Garden Wildlife Products](#)

GardenBirds.com specializes in distinctive bird houses, bird feeders, bird baths and other products for garden wildlife. We have a free shipping offer and your satisfaction is guaranteed.

<http://www.GardenBirds.com/> [Sponsored Link](#)

[InsideSun Discount Garden Supplies](#)

InsideSun is your one-stop-shop for growing needs. Complete 400w HPS system only \$90. Huge discounts on MH too. Light systems and bulbs, hydroponics, nutrients, CO2, carbon scrubbers and more!

<http://www.insidesun.com/> [Sponsored Link](#)

[Home Harvest Garden Supply](#)

Fertilizers, compost, soil, discount seeds, greenhouses, nursery supplies, pest controls, pots, propagation, hydroponics, season extenders, grow lights and lots more at Home Harvest Garden Supply!

<http://homeharvest.com/> [Sponsored Link](#)

[Keep Your Home Safe - ADT](#)

Help protect your family and your home. Free security systems and free security reviews. Install a home security system from your local ADT Authorized Dealer. Find out more.

<http://www.KeepYourHomeSafe.com> [Sponsored Link](#)

[Home and Garden shopping at FurnitureFind.com!](#)

Browse a large selection of home and garden furnishings. Find quality, name brand furniture, save 30-50% and get free delivery! Call us today to take advantage of our free personal shopper service.

<http://www.furniturefind.com/> [Sponsored Link](#)

[Buy a Link Now!](#)

Explore More on the About Network!

| | | | | |
|---|--|---|---|----------------------------|
| <p>Related Sites</p> <p>Architecture Birding/Wild Birds Gardening Home Repair</p> | <p><u>Large Rats</u></p> <p>Exotic Pets Guide Lianne McLeod introduces you to the 30-inch long Gambian Giant Rat.</p> | <p><u>Decision 2004</u></p> <p>With Wesley Clark officially in the race, U.S. Politics Guide Anne Linskey looks at all the candidates.</p> | <p><u>Malcolm X</u></p> <p>African-American History Guide Jessica McElrath tells us about the life of Malcolm X.</p> | <p>Search About</p> |
|---|--|---|---|----------------------------|

[About Us](#) | [Advertise on This Site](#) | [User Agreement](#) | [Privacy Policy](#) | [Kids' Privacy Policy](#) | [Help](#)

Copyright © 2003 About, Inc. About and About.com are registered trademarks of About, Inc. The About logo is a trademark of About, Inc. All rights reserved.



Landscaping

with [David Beaulieu](#)

Your Guide to one of [hundreds of sites](#)

[Home](#) · [Articles](#) · [Forums](#) · [Chat](#) · [Newsletters](#) · [Help](#)

Subjects

ESSENTIALS

- [Landscaping Glossary](#)
- [Landscape Solutions](#)
- [Landscaping 101](#)
- [Landscape Design for Beginners](#)
- [Landscaping FAQs](#)

BUYER'S GUIDE

- [Landscape Design](#)
- [Ornamental Trees](#)
- [Fall Foliage Trees](#)
- [Shrub Fall Colors](#)
- [Cheap Landscaping](#)
- [Easy Landscaping](#)
- [Landscape Plans](#)
- [Rock Gardens](#)
- [Patios, Walls](#)
- [Design for Birds](#)
- [Garden Pests](#)
- [Weed Control](#)
- [Bonsai, Japanese](#)
- [Shrubs, Bushes](#)
- [Decks and Arbors](#)
- [Links](#)
- [Hedges, Fences](#)
- [Compost and Mulch](#)
- [Fruit Trees](#)
- [Ground Cover Vines](#)
- [Garden Accents](#)

Building Wood Arbors for Patio, Deck and Garden

page 3

A Free Design for Beginners

The garden arbor posts secured in the ground, we now move on to the next steps involved in the process of building a wood arbor for your patio, deck or garden:

- **An Optional Design for Added Flair:**

Cutting a design into the ends of your crosspieces is simple with a jigsaw. First trace out the design on the lumber with a pencil. Getting a rounded edge can be as simple for beginners as tracing around a saucer.

- Once you have one end-design cut out, use it as a template for the other three.
- **Next Architectural Layer -- the**

Rafters: Five rafters will sit atop the crosspieces, and they'll be 4' long. So cut up your 2x4s now with a



Notch the arbor rafters for a tighter fit.

David Beaulieu

[Email to a friend](#)

[Printer friendly version](#)

All Articles on Landscaping

- [Previous Articles](#)

Join the Discussion

- [Solving Drainage Problems](#)

Related Resources

- [How to Build Brick Patios](#)
- [Backyard Water Fountains](#)
- [How to Build Concrete Patios](#)

About Landscaping

Subscribe to the Free Newsletter

Your Email Address:

[Houseplants](#)
[Pond, Water Garden](#)
[Software, Hire Pro](#)
[Soil, Fertilizer](#)
[Rose Bushes](#)
[Lawn Care](#)
[Year-round Color](#)
[Gift Ideas](#)
[Top Picks](#)

[Subject Library](#)

[All articles on this topic](#)

Stay up-to-date!
Subscribe to our newsletter.

ResultsAbout

New from About.com!

[Get Paid to Improve Search](#)

Find Results Now:

[Feng Shui](#)
[Rolling Stones](#)
[Atkins Diet](#)
[Elvis Presley](#)
[Log Homes](#)

Advertising
> [Free Credit Report](#)

handsaw or circular saw to make these rafters.

Notching the Rafters

- Now we'll notch the rafters, for a tighter fit atop the crosspieces. Note also that, by adjusting the depth of the individual notches, you can correct discrepancies in levelness. This can be important when working with discount lumber. For instance, if one of the crosspieces is "bowed" (higher in the center than on the ends), your only chance to make the proper adjustments may well lie in your notching.
- Lay each rafter down on the ground the long way, so that one of the 2" dimensions is on the ground, the other facing up. On the part facing up, find the center point lengthwise. From this center point, measure out 1 3/4" to the left (mark with pencil) and 1 3/4" to the right (mark with pencil).
- Now simply repeat the last step, except you'll be going over another 1" on both the left and the right.
- It is from these two 1" areas, on either side of the 3.5" center area, that the notches will be cut (for a picture, see photo above). The notches will fit over the two 1" wide crosspieces.
- On each side of the 4" dimension, measure down 1". Make several 1" cuts down into this notch area, using whatever saw you're most comfortable with.
- Now go back with a hammer and wood chisel and strike into these cuts; chips of wood will start coming out, and you'll have a notch in no time. After chiseling, take a wood file and file away some of the roughness on the chiseled surface. Repeat for each (you'll have ten notches in all).
- Now that the cuts have been made, the focus switches to attaching the boards together to assemble the garden arbor.

The first step in assembling the garden arbor is to line up the crosspieces and the 4x4 posts. Once lined up properly, you'll be boring a hole that will stretch through all three pieces of wood, allowing you to insert a bolt that will unite the three pieces. You'll begin at one post, and then repeat the process on the other post.

Assembling the Garden Arbor:

- If you're not confident enough with your measuring skills to pre-bore all the holes and then fit everything together after, then it's time to bring the crosspieces over to the 4x4 posts, so that they can be lined up properly.
- First measure down 6" from the top of each post, on either the outer or inner side (doesn't matter which), and mark it with a pencil. For each post, take a small piece of scrap lumber, and screw it into the post with a couple of screws, so that the top of the scrap lumber runs along the line you just drew. Pick scrap lumber that is long enough so that it will protrude a couple of inches or so beyond each side of the post. These little "shelves" will function as temporary supports for your crosspieces.
- Now take one of the crosspieces and lay it across one of the temporary shelves (either front or back). The crosspiece should now be positioned in just the way that it will eventually lie, when the project is done.
- With this crosspiece lined up properly with respect to the posts, attach each end with a couple of screws, one near the top, one near the bottom. Repeat with the other crosspiece. Now you can remove the two temporary shelves that the crosspieces are resting on.

On Page 4 we move on the boring of the holes. Page 4 also contains a free garden arbor plan that beginners may find useful as a visual reference....

[previous](#) | [1](#) | [2](#) | **[3](#)** | [4](#) | [5](#) | [next](#)

[Email this page!](#)

Sponsored Links

[Be the first Sponsored Links advertiser on this site...](#)

Start driving targeted traffic to your site with Sprinks, About's Sponsored Links program.

<http://sprinks.about.com/>

[Buy a Link Now!](#)

Explore More on the About Network!

| | | | | |
|--|--|---|---|---------------------|
| Related Sites Architecture Birding/Wild Birds Gardening Home Repair | Large Rats Exotic Pets Guide Lianne McLeod introduces you to the 30-inch long Gambian Giant Rat. | Decision 2004 With Wesley Clark officially in the race, U.S. Politics Guide Anne Linskey looks at all the candidates. | Malcolm X African-American History Guide Jessica McElrath tells us about the life of Malcolm X. | Search About |
|--|--|---|---|---------------------|

[About Us](#) | [Advertise on This Site](#) | [User Agreement](#) | [Privacy Policy](#) | [Kids' Privacy Policy](#) | [Help](#)

Copyright © 2003 About, Inc. About and About.com are registered trademarks of About, Inc. The About logo is a trademark of About, Inc. All rights reserved.



Landscaping

with [David Beaulieu](#)

Your Guide to one of [hundreds of sites](#)

[Home](#) · [Articles](#) · [Forums](#) · [Chat](#) · [Newsletters](#) · [Help](#)

Subjects

ESSENTIALS

- [Landscaping Glossary](#)
- [Landscape Solutions](#)
- [Landscaping 101](#)
- [Landscape Design for Beginners](#)
- [Landscaping FAQs](#)

BUYER'S GUIDE

[Landscape Design](#)

[Ornamental Trees](#)

[Fall Foliage Trees](#)

[Shrub Fall Colors](#)

[Cheap Landscaping](#)

[Easy Landscaping](#)

[Landscape Plans](#)

[Rock Gardens](#)

[Patios, Walls](#)

[Design for Birds](#)

[Garden Pests](#)

[Weed Control](#)

[Bonsai, Japanese](#)

[Shrubs, Bushes](#)

[Decks and Arbors](#)

[Links](#)

[Hedges, Fences](#)

[Compost and Mulch](#)

[Fruit Trees](#)

[Ground Cover Vines](#)

[Garden Accents](#)

Free Garden Arbor Plan

page 4

Follow the Plan, Build the Arbor: It's Easy!

After completing the work on Page 3, you're now ready to make your wooden garden arbor design come to life! The next step in the building process is to tie your crosspieces and posts together. While following these steps, please refer to the free garden arbor plan (see the picture on the right):

- Insert a spade borer into a drill. The width of the borer will have to match the width of the bolts that you've chosen. I chose 1/4" bolts, so I used a 1/4" spade borer.
- With posts and crosspieces lined up (see Page 3), you can now use the drill with its attached spade borer to drill a hole through the crosspieces and posts (both left post and right).
- When boring the holes, keep the drill as level and as straight as possible. You don't want to end up with the front hole an inch higher than the back hole, say.
- If the borer doesn't penetrate all the way through,



Color codes indicate both board dimensions and order of placement: purple goes first, yellow last.
David Beaulieu

[Email to a friend](#)

[Printer friendly version](#)

All Articles on Landscaping

- [Previous Articles](#)

Join the Discussion

- [Solving Drainage Problems](#)

Related Resources

- [How to Build Brick Patios](#)
- [Backyard Water Fountains](#)
- [How to Build Concrete Patios](#)

About Landscaping

Subscribe to the Free Newsletter
Your Email

Address:

- [Houseplants](#)
- [Pond, Water Garden](#)
- [Software, Hire Pro](#)
- [Soil, Fertilizer](#)
- [Rose Bushes](#)
- [Lawn Care](#)
- [Year-round Color](#)
- [Gift Ideas](#)
- [Top Picks](#)

[Subject Library](#)

[All articles on this topic](#)

Stay up-to-date!
Subscribe to our newsletter.

Results About

New from About.com!

[Get Paid to Improve Search](#)

Find Results Now:

- [Feng Shui](#)
- [Rolling Stones](#)
- [Atkins Diet](#)
- [Elvis Presley](#)
- [Log Homes](#)

Advertising

> [Free Credit Report](#)

there's an easy way to avoid having to drill first from one side, then from the other, hoping the two holes will meet. That's a bit too dicey for me. Instead, take the easy way out! Bore through as far as you can (you should be able to get half way into the post, anyhow), then remove the crosspiece that you've drilled through. Now continue boring through the post. You should be able at least to pierce the other crosspiece. Then you can widen the entry by switching sides and boring through the other crosspiece.

- Now hammer the bolts through the holes, and apply the washers and nuts.
- Take the rafters that you've already notched, and just slip them over the crosspieces, perpendicular to them. The notches will tell you where they fit, if you've measured properly in your notching; so this step is easy.
- Attach the rafters to the crosspieces with deck screws.
- Finally, lay the 2x2s on top of the rafters, perpendicular to them. Attach with screws.
- And you're done! Wait at least 6 months before staining your pressure-treated wood.

Because of the wait involved before you can stain the wood of your garden arbor, you won't be able to plant any vines on it for that first summer. Instead, spend the time looking at other people's arbors, and see what plant choices catch your eye.

Climbing roses and wisteria are two widespread [aesthetic](#) uses for arbors. Meanwhile, trellising grapes on arbors is a traditional [horticultural](#) use of arbors. But at this point in the discussion, we have moved beyond the *building* of arbors to a treatment of their function. And that, along with other arbor miscellany, is the subject of Page 5....

[previous](#) | [1](#) | [2](#) | [3](#) | **4** | [5](#) | [next](#)

[Email this page!](#)

Sponsored Links

[Distinctive Wild Bird and Garden Wildlife Products](#)

GardenBirds.com specializes in distinctive bird houses, bird feeders, bird baths and other products for garden wildlife. We have a free shipping offer and your satisfaction is guaranteed.

<http://www.GardenBirds.com/> [Sponsored Link](#)

InsideSun Discount Garden Supplies

InsideSun is your one-stop-shop for growing needs. Complete 400w HPS system only \$90. Huge discounts on MH too. Light systems and bulbs, hydroponics, nutrients, CO2, carbon scrubbers and more!

<http://www.insidesun.com/> [Sponsored Link](#)

Home Harvest Garden Supply

Fertilizers, compost, soil, discount seeds, greenhouses, nursery supplies, pest controls, pots, propagation, hydroponics, season extenders, grow lights and lots more at Home Harvest Garden Supply!

<http://homeharvest.com/> [Sponsored Link](#)

Keep Your Home Safe - ADT

Help protect your family and your home. Free security systems and free security reviews. Install a home security system from your local ADT Authorized Dealer. Find out more.

<http://www.keepyourhomesafe.com> [Sponsored Link](#)

Home and Garden shopping at FurnitureFind.com!

Browse a large selection of home and garden furnishings. Find quality, name brand furniture, save 30-50% and get free delivery! Call us today to take advantage of our free personal shopper service.

<http://www.furniturefind.com/> [Sponsored Link](#)

Buy a Link Now!

Explore More on the About Network!

| | | | | |
|---|--|---|---|----------------------------|
| <p>Related Sites</p> <p>Architecture Birding/Wild Birds Gardening Home Repair</p> | <p><u>Large Rats</u></p> <p>Exotic Pets Guide Lianne McLeod introduces you to the 30-inch long Gambian Giant Rat.</p> | <p><u>Decision 2004</u></p> <p>With Wesley Clark officially in the race, U.S. Politics Guide Anne Linskey looks at all the candidates.</p> | <p><u>Malcolm X</u></p> <p>African-American History Guide Jessica McElrath tells us about the life of Malcolm X.</p> | <p>Search About</p> |
|---|--|---|---|----------------------------|

[About Us](#) | [Advertise on This Site](#) | [User Agreement](#) | [Privacy Policy](#) | [Kids' Privacy Policy](#) | [Help](#)

Copyright © 2003 About, Inc. About and About.com are registered trademarks of About, Inc. The About logo is a trademark of About, Inc. All rights reserved.



Landscaping

with [David Beaulieu](#)Your Guide to one of [hundreds of sites](#)
[Home](#) · [Articles](#) · [Forums](#) · [Chat](#) · [Newsletters](#) · [Help](#)

Subjects

ESSENTIALS

- [Landscaping Glossary](#)
- [Landscape Solutions](#)
- [Landscaping 101](#)
- [Landscape Design for Beginners](#)
- [Landscaping FAQs](#)

BUYER'S GUIDE

- [Landscape Design](#)
- [Ornamental Trees](#)
- [Fall Foliage Trees](#)
- [Shrub Fall Colors](#)
- [Cheap Landscaping](#)
- [Easy Landscaping](#)
- [Landscape Plans](#)
- [Rock Gardens](#)
- [Patio, Walls](#)
- [Design for Birds](#)
- [Garden Pests](#)
- [Weed Control](#)
- [Bonsai, Japanese](#)
- [Shrubs, Bushes](#)
- [Decks and Arbors](#)
- [Links](#)
- [Hedges, Fences](#)
- [Compost and Mulch](#)
- [Fruit Trees](#)
- [Ground Cover Vines](#)
- [Garden Accents](#)

Arbor Day History and Shady Grape Arbors

page 5

The Difference Between "Trellises," "Arbors" and "Pergolas"

You've probably heard of "Arbor Day," and perhaps you've wondered what that celebration has to do with grape "arbors" and other arbors used in landscaping. The origin of Arbor Day (or "Arbour" Day, to use the British spelling) lies in 19th century history. It is a day on which trees are honored. People plant trees on Arbor Day to celebrate the importance of trees to human life.

What of the linguistic history, or etymology, behind Arbor Day? Well, it is called **Arbor** Day because *arbor* is the Latin word for "tree" (the derivation of the "arbors" that we're dealing with, however, is *not* from this Latin word). Is there a connection between garden arbors and trees? According to Random House Dictionary, an **arbor** first and foremost is "a leafy, shady recess formed by tree branches, shrubs, etc." Only secondarily is an arbor defined as "a latticework bower intertwined with climbing vines and flowers." Clearly, then, the garden arbors that we build and train vines upon (i.e., "latticework bowers") have been developed out of a need to find stand-ins for shade-giving trees.

So that's about the extent of the connection between Arbor

 [Email to a friend](#)
 [Printer friendly version](#)

All Articles on Landscaping

- [Previous Articles](#)

Join the Discussion

- [Solving Drainage Problems](#)

Related Resources

- [How to Build Brick Patios](#)
- [Backyard Water Fountains](#)
- [How to Build Concrete Patios](#)

About Landscaping

Subscribe to the Free Newsletter
Your Email

Address:

[Houseplants](#)
[Pond, Water Garden](#)
[Software, Hire Pro](#)
[Soil, Fertilizer](#)
[Rose Bushes](#)
[Lawn Care](#)
[Year-round Color](#)
[Gift Ideas](#)
[Top Picks](#)

[Subject Library](#)

[All articles on this topic](#)

Stay up-to-date!
Subscribe to our newsletter.

ResultsAbout

New from About.com!

[Get Paid to Improve Search](#)

Find Results Now:

[Feng Shui](#)

[Rolling Stones](#)

[Atkins Diet](#)

[Elvis Presley](#)

[Log Homes](#)

Advertising

> [Free Credit Report](#)

Day and garden arbors, such as grape arbors. In other words, it would be something of a stretch to connect them, despite their shared use of the word, "arbor." If you want to celebrate Arbor Day faithfully, plant a tree; save your plans for building a garden arbor for another day.

ArborDay.org relates the full history of Arbor Day celebrations. According to this site, it was on January 4, 1872 that J. Sterling Morton first proposed a tree-planting holiday to be called "Arbor Day." The proposal was made in Nebraska, which at the time was more or less a tree-less state. Morton's proposal was adopted, and the idea of observing an Arbor Day spread to other states later in the 1870s. States today most commonly observe Arbor Day on the last Friday in April. The observance of Arbor Day has even spread beyond the borders of the U.S.

What Are Garden Arbors Used For?

Arbors have many uses. For instance, there are the classic grape arbors, in which case the arbor has a horticultural function -- serving as a trellis for the grape crop. Arbors -- in conjunction with the vines that grow on them -- can also serve as privacy screens. Another function of the arbor is to provide shade, including deck arbors and patio arbors (arbors built over decks or patios to furnish them with shade). More often, arbors have an aesthetic purpose. Some landscapers like the look of a wooden arbor that forms an entrance to a garden. Likewise, arbors can function as entry gates for properties surrounded by fencing.

Trellises, Pergolas and Arbors

Two terms often associated with arbors are "[pergola](#)" and "trellis." Any structure, including an arbor, designed specifically to support vines is often called a trellis now, although traditional trellis design specifically involves the use of [latticework](#).

Distinguishing pergolas from arbors is more of a challenge. Oversimplifying for the sake of brevity, it may help to focus on the fact that the word, *pergola* is Italian. Renaissance Italy loved its pergolas, which were essentially arbors with [masonry](#) columns, rather than wooden posts.

But this distinction, based on whether the supports are wooden or masonry, is breaking down now, as people use the term "pergola" more loosely. If there's any distinction at all that is still maintained, perhaps it is that pergolas are structures of somewhat more substantial architecture than are arbors. And if you're invited to a party at a house with a pergola, you're more likely to be served sherry than plain old wine....

~ [David Beaulieu](#)

[previous](#) | [1](#) | [2](#) | [3](#) | [4](#) | [5](#)

[Email this page!](#)

Sponsored Links

[Distinctive Wild Bird and Garden Wildlife Products](#)

GardenBirds.com specializes in distinctive bird houses, bird feeders, bird baths and other products for garden wildlife. We have a free shipping offer and your satisfaction is guaranteed.

<http://www.GardenBirds.com/> [Sponsored Link](#)

[InsideSun Discount Garden Supplies](#)

InsideSun is your one-stop-shop for growing needs. Complete 400w HPS system only \$90. Huge discounts on MH too. Light systems and bulbs, hydroponics, nutrients, CO2, carbon scrubbers and more!

<http://www.insidesun.com/> [Sponsored Link](#)

[Home Harvest Garden Supply](#)

Fertilizers, compost, soil, discount seeds, greenhouses, nursery supplies, pest controls, pots, propagation, hydroponics, season extenders, grow lights and lots more at Home Harvest Garden Supply!

<http://homeharvest.com/> [Sponsored Link](#)

[Keep Your Home Safe - ADT](#)

Help protect your family and your home. Free security systems and free security reviews. Install a home security system from your local ADT Authorized Dealer. Find out more.

<http://www.KeepYourHomeSafe.com> [Sponsored Link](#)

[Home and Garden shopping at FurnitureFind.com!](#)

Browse a large selection of home and garden furnishings. Find quality, name brand furniture, save 30-50% and get free delivery! Call us today to take advantage of our free personal shopper service.

<http://www.furniturefind.com/> [Sponsored Link](#)

[Buy a Link Now!](#)

Explore More on the About Network!

| | | | | |
|--|---|--|--|---------------------|
| Related Sites Architecture Birding/Wild Birds Gardening Home Repair | <u>Large Rats</u> Exotic Pets Guide Lianne McLeod introduces you to the 30-inch long Gambian Giant Rat. | <u>Decision 2004</u> With Wesley Clark officially in the race, U.S. Politics Guide Anne Linskey looks at all the candidates. | <u>Malcolm X</u> African-American History Guide Jessica McElrath tells us about the life of Malcolm X. | Search About |
|--|---|--|--|---------------------|

[About Us](#) | [Advertise on This Site](#) | [User Agreement](#) | [Privacy Policy](#) | [Kids' Privacy Policy](#) | [Help](#)

Copyright © 2003 About, Inc. About and About.com are registered trademarks of About, Inc. The About logo is a trademark of About, Inc. All rights reserved.



Landscaping

with [David Beaulieu](#)

Your Guide to one of [hundreds of sites](#)

[Home](#) · [Articles](#) · [Forums](#) · [Chat](#) · [Newsletters](#) · [Help](#)

Subjects

ESSENTIALS

- [Landscaping Glossary](#)
- [Landscape Solutions](#)
- [Landscaping 101](#)
- [Landscape Design for Beginners](#)
- [Landscaping FAQs](#)

BUYER'S GUIDE

- [Landscape Design](#)
- [Ornamental Trees](#)
- [Fall Foliage Trees](#)
- [Shrub Fall Colors](#)
- [Cheap Landscaping](#)
- [Easy Landscaping](#)
- [Landscape Plans](#)
- [Rock Gardens](#)
- [Patios, Walls](#)
- [Design for Birds](#)
- [Garden Pests](#)
- [Weed Control](#)
- [Bonsai, Japanese](#)
- [Shrubs, Bushes](#)
- [Decks and Arbors](#)
- [Links](#)

Landscaping 101: What is Landscape Design?

Part 1: A Definition of Practical and Aesthetic Landscape Design



Photo by David Beaulieu

Windbreaks can be attractive, as well as functional.

[Hedges, Fences](#)

[Compost and Mulch](#)

[Fruit Trees](#)

[Ground Cover Vines](#)

[Garden Accents](#)

[Houseplants](#)

[Pond, Water Garden](#)

[Software, Hire Pro](#)

[Soil, Fertilizer](#)

[Rose Bushes](#)

[Lawn Care](#)

[Year-round Color](#)

[Gift Ideas](#)

[Top Picks](#)

[Subject Library](#)

[All articles on this topic](#)

Stay up-to-date!

Subscribe to our newsletter.

Results About

New from About.com!

[Get Paid to Improve Search](#)

Find Results Now:

[Feng Shui](#)

[Rolling Stones](#)

[Atkins Diet](#)

[Elvis Presley](#)

[Log Homes](#)

What is landscape design? To be sure, both "landscape" and "design" are common, everyday words -- not terms that would send you scurrying to a dictionary. But asking ourselves as do it yourselfers *exactly* what **landscape design** entails is a useful exercise: by exploring all of its ins and outs, we may discover an aspect of this diverse field that we've been overlooking all this time. Let's begin answering the question with a basic definition of landscape design for homeowners that considers both aesthetics and energy conservation.

Definition of Landscape Design:

The art of arranging or modifying the features of the grounds around a home to improve the property from an aesthetic and/or practical standpoint.

This definition, however, raises the questions, "Aesthetic *for whom?*" and "Practical *for whom?*" The issue of **aesthetics**, in particular, is fraught with subjectivity. Frankly, what I find to be an ideally attractive landscape might not excite you at all. But this does not mean that nothing needs to be said about landscape aesthetics for the do it yourselfer.

You may have your own distinct tastes, but there are still useful guidelines to discuss that will help you achieve maximum aesthetic impact on your landscape. If your property is destined for the real estate market, please consult **[Ideas for Home Landscaping](#)** to learn specifically about sellers' guidelines; essentially, you will need to take into account the tastes of potential buyers. If, instead, you are landscaping simply to suit your own tastes, you'll want to keep in mind the general design guidelines for landscape aesthetics discussed in Part 2 and Part 3.

Practical Landscape Design: Energy Conservation With Trees, Land Use

How will your yard be used? Do you have children who are active outdoors? Do you yourself plan on using your yard for exercise,

More of this Feature

- **[Part 2: Trees and Hardscape in Landscape Design](#)**
- **[Part 3: Outdoor Lighting and Gardens in Landscape Design](#)**

Related Resources

- **[Landscape Design Theory for Beginners](#)**
- **[Ideas for Home Landscaping](#)**
- **[Landscape Design FAQs](#)**

Elsewhere on the Web

- **[Landscape Design for Energy Conservation](#)**
- **[Energy Conservation Through Landscape Design](#)**

Advertising

> [Free Credit Report](#)

sports, or entertaining? Answering these questions will help determine the appropriate landscape design for your needs. Extensive lawn space is useful in a yard that will see a lot of social barbecues, badminton and ball playing. But if you are more interested in turning your yard into a retreat meant for serenity, solitude and contemplation, the role of turf grass may be reduced drastically in favor of trees.

The various aspects of practical landscape design are too numerous and too complex to discuss at length here. Undoubtedly, however, one aspect that warrants inclusion in any introduction to landscape design is **energy conservation**. A well-planned incorporation of trees and shrubs in your yard, as in the following examples, is an effective means of energy conservation:

- [Deciduous](#) trees can be planted to the south and west of a home to serve as shade trees, reducing summer air conditioning costs. Because such trees will drop their leaves in winter, they won't deprive your home of sunlight when you *need* it.
- Evergreen trees planted to the north and west of a home can serve as windbreaks, as detailed by [William C. Welch](#). By breaking the wind, such trees will reduce your heating costs in winter.
- Likewise, shrubs used as foundation plantings can reduce heating costs, creating an insulating dead air space around the home. Plant the shrubs 5' away from your foundation.

But after such practical concerns have been addressed, you'll still want to make your landscape design as aesthetically pleasing as possible. Page 2 begins by laying the groundwork....

Next page > [Trees and Hardscape](#) > Page **1**, [2](#), [3](#)

[Email this page!](#)

Sponsored Links

[Distinctive Wild Bird and Garden Wildlife Products](#)

GardenBirds.com specializes in distinctive bird houses, bird feeders, bird baths and other products for garden wildlife. We have a free shipping offer and your satisfaction is guaranteed.

<http://www.GardenBirds.com/> [Sponsored Link](#)

[InsideSun Discount Garden Supplies](#)

InsideSun is your one-stop-shop for growing needs. Complete 400w HPS system only \$90. Huge discounts on MH too. Light systems and bulbs, hydroponics, nutrients, CO2, carbon scrubbers and more!

<http://www.insidesun.com/> [Sponsored Link](#)

Home Harvest Garden Supply

Fertilizers, compost, soil, discount seeds, greenhouses, nursery supplies, pest controls, pots, propagation, hydroponics, season extenders, grow lights and lots more at Home Harvest Garden Supply!

<http://homeharvest.com/> [Sponsored Link](#)

Keep Your Home Safe - ADT

Help protect your family and your home. Free security systems and free security reviews. Install a home security system from your local ADT Authorized Dealer. Find out more.

<http://www.keepyourhomesafe.com> [Sponsored Link](#)

Home and Garden shopping at FurnitureFind.com!

Browse a large selection of home and garden furnishings. Find quality, name brand furniture, save 30-50% and get free delivery! Call us today to take advantage of our free personal shopper service.

<http://www.furniturefind.com/> [Sponsored Link](#)

Buy a Link Now!

Explore More on the About Network!

| | | | | |
|---|---|--|--|----------------------------|
| <p>Related Sites</p> <p>Architecture Birding/Wild Birds Gardening Home Repair</p> | <p>Large Rats</p> <p>Exotic Pets Guide Lianne McLeod introduces you to the 30-inch long Gambian Giant Rat.</p> | <p>Decision 2004</p> <p>With Wesley Clark officially in the race, U.S. Politics Guide Anne Linskey looks at all the candidates.</p> | <p>Malcolm X</p> <p>African-American History Guide Jessica McElrath tells us about the life of Malcolm X.</p> | <p>Search About</p> |
|---|---|--|--|----------------------------|

[About Us](#) | [Advertise on This Site](#) | [User Agreement](#) | [Privacy Policy](#) | [Kids' Privacy Policy](#) | [Help](#)

Copyright © 2003 About, Inc. About and About.com are registered trademarks of About, Inc. The About logo is a trademark of About, Inc. All rights reserved.



Landscaping

with [David Beaulieu](#)

Your Guide to one of [hundreds of sites](#)

[Home](#) · [Articles](#) · [Forums](#) · [Chat](#) · [Newsletters](#) · [Help](#)

Subjects

ESSENTIALS

- [Landscaping Glossary](#)
- [Landscape Solutions](#)
- [Landscaping 101](#)
- [Landscape Design for Beginners](#)
- [Landscaping FAQs](#)

BUYER'S GUIDE

- [Landscape Design](#)
- [Ornamental Trees](#)
- [Fall Foliage Trees](#)
- [Shrub Fall Colors](#)
- [Cheap Landscaping](#)
- [Easy Landscaping](#)
- [Landscape Plans](#)
- [Rock Gardens](#)
- [Patios, Walls](#)
- [Design for Birds](#)
- [Garden Pests](#)
- [Weed Control](#)
- [Bonsai, Japanese](#)
- [Shrubs, Bushes](#)
- [Decks and Arbors](#)
- [Links](#)

Landscaping 101: What is Landscape Design?

Part 2: Trees, Decks, Fences, Patios, Water Gardens

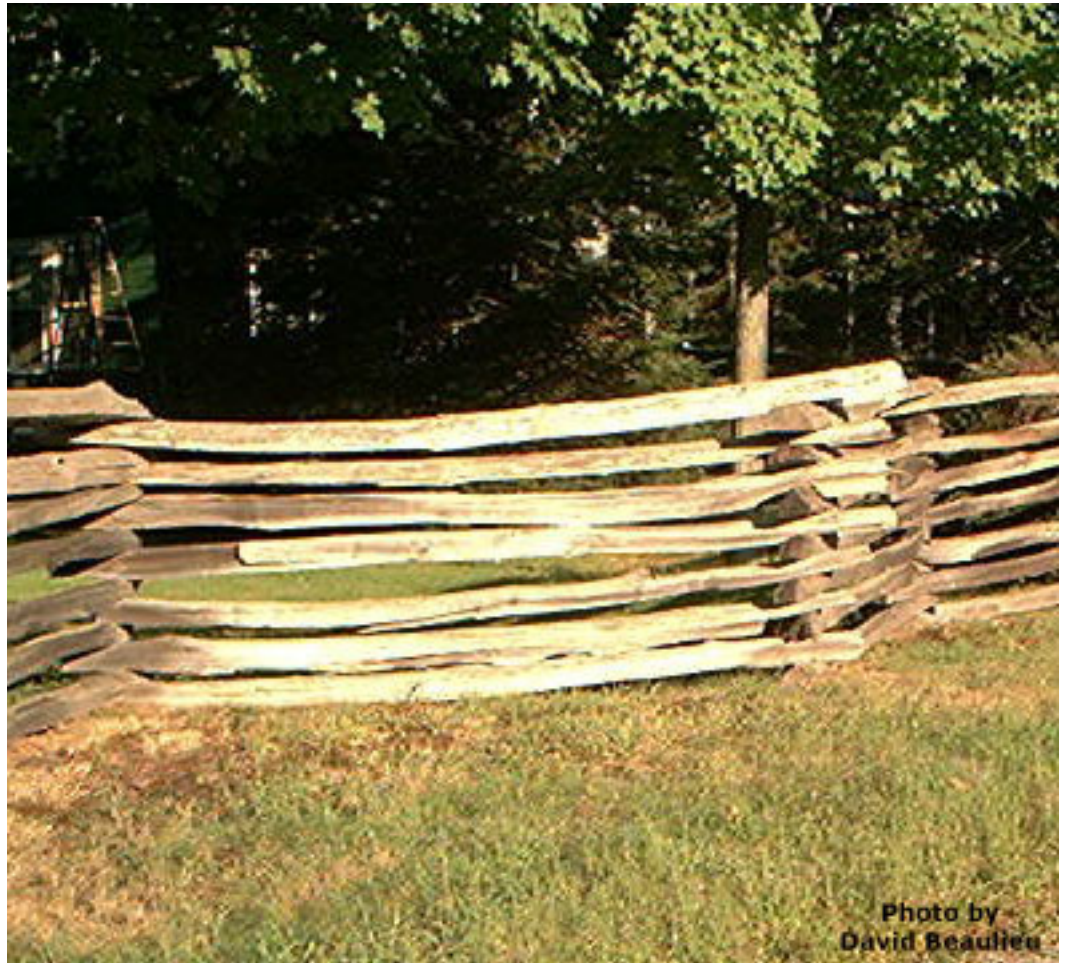

Photo by David Beaulieu

Hardscape features such as fences provide structure for a landscape design.

[Hedges, Fences](#)

[Compost and Mulch](#)

[Fruit Trees](#)

[Ground Cover Vines](#)

[Garden Accents](#)

[Houseplants](#)

[Pond, Water Garden](#)

[Software, Hire Pro](#)

[Soil, Fertilizer](#)

[Rose Bushes](#)

[Lawn Care](#)

[Year-round Color](#)

[Gift Ideas](#)

[Top Picks](#)

[Subject Library](#)

[All articles on this topic](#)

Stay up-to-date!

Subscribe to our newsletter.

ResultsAbout

New from About.com!

[Get Paid to Improve Search](#)

Find Results Now:

[Feng Shui](#)

[Rolling Stones](#)

[Atkins Diet](#)

[Elvis Presley](#)

[Log Homes](#)

Turning to the aesthetics of your landscape design, you first have some decisions to make regarding **hardscape**, existing trees, and what you'll have as a view when you gaze out the window. Getting this part of the project right will make implementing the softscape refinements relatively easy. Hardscape features include:

- **Fences** and walls
- **Patios** and **decks**
- Stone or brick walkways
- Gazebos and arbors
- Statuary, **water gardens** and fountains

If you were giving a room a total makeover, you wouldn't start by hanging pictures and arranging knickknacks, would you? Of course not: such fragile refinements would simply be in the way as you did the heavier work, such as stripping the walls and moving furniture. You save the refinements for last.

The way to begin a landscape makeover is not so very different, in principle. You begin with the heavier work -- the foundation for your landscape aesthetics -- leaving for last such icing on the cake as the planting of flower beds. Some basic guidelines follow for getting your landscape design project underway.

Unity, Vistas, Privacy Screens

- Your landscape should be in harmony with your home, to ensure **unity** in the overall appearance of the property. One consideration influencing unity is **proportion**. Large trees are in proportion with large homes, but are *out of proportion* with smaller homes. When in doubt, however, leave the tree in place -- provided that it doesn't pose a safety hazard.
- Accentuate desirable views. If you live on a rural hillside with the potential for panoramic views of a valley and surrounding hills, you probably won't want your home to be entirely encased in trees that will obstruct your view. Don't cut down *all* the trees, though. Determine what your finest vistas are, clear the trees in just those areas, and use the remaining trees to **frame** those nice views. When set off

More of this Feature

- [Part 1: Definition of Landscape Design](#)
- [Part 3: Outdoor Lighting and Gardens in Landscape Design](#)

Related Resources

- [Landscape Design With Stone](#)
- [Concrete Patio Floor Design](#)
- [How to Build a Concrete Patio](#)

Elsewhere on the Web

- [Landscape Design for Energy Conservation](#)
- [Energy Conservation Through Landscape Design](#)

Advertising

> [Free Credit Report](#)

like a picture by grand trees to the left and right, nice views become truly spectacular views!

- By contrast, you'll want to block out undesirable views. A suburban home with close neighbors is an ideal candidate for a **privacy screen**. In addition to hedges, some of the options for privacy screens include the following hardscape features:
 - Wooden fences
 - Vinyl fences
 - [Masonry](#) walls

With the hardscape already in place, it will be easier later to integrate the softscape with it in a seamless fashion. In the case of some hardscape features, complementary softscape elements are so commonly used in conjunction with them as to come to mind immediately. Let's look at these briefly.

Integration of Hardscape and Softscape

Water gardens, particularly those with fountains or statuary, can supply your landscape design with a focal point. Because such a water feature is, by itself, so impressive, the softscape needed to make it a true "garden" is rather minimal. A few container-held aquatic plants would be sufficient to complete the design. But certainly more elaborate softscape treatments are possible as well.

Similarly, in installing gazebos, arbors, decks and patios you are laying the groundwork to display your softscape elements in a more favorable light than would be possible without hardscape. A vine on a well-located arbor becomes more than just a vine: it becomes a festive garland beckoning us to pass under its arch. Gazebos, patios and decks are all excellent choices for showcasing window boxes and potted specimen plants.

Now that the structure is in place, on Page 3 let's shed some light on gardens....

Next page > [Outdoor Lighting and Gardens](#) > Page [1](#), [2](#), [3](#)

[Email this page!](#)

Sponsored Links

[Distinctive Wild Bird and Garden Wildlife Products](#)

GardenBirds.com specializes in distinctive bird houses, bird feeders, bird baths and other products for garden wildlife. We have a free shipping offer and your satisfaction is guaranteed.

<http://www.GardenBirds.com/> [Sponsored Link](#)

InsideSun Discount Garden Supplies

InsideSun is your one-stop-shop for growing needs. Complete 400w HPS system only \$90. Huge discounts on MH too. Light systems and bulbs, hydroponics, nutrients, CO2, carbon scrubbers and more!

<http://www.insidesun.com/> [Sponsored Link](#)

Home Harvest Garden Supply

Fertilizers, compost, soil, discount seeds, greenhouses, nursery supplies, pest controls, pots, propagation, hydroponics, season extenders, grow lights and lots more at Home Harvest Garden Supply!

<http://homeharvest.com/> [Sponsored Link](#)

Keep Your Home Safe - ADT

Help protect your family and your home. Free security systems and free security reviews. Install a home security system from your local ADT Authorized Dealer. Find out more.

<http://www.keepyourhomesafe.com> [Sponsored Link](#)

Home and Garden shopping at FurnitureFind.com!

Browse a large selection of home and garden furnishings. Find quality, name brand furniture, save 30-50% and get free delivery! Call us today to take advantage of our free personal shopper service.

<http://www.furniturefind.com/> [Sponsored Link](#)

Buy a Link Now!

Explore More on the About Network!

| | | | | |
|---|--|--|---|----------------------------|
| <p>Related Sites</p> <p>Architecture</p> <p>Birding/Wild Birds</p> <p>Gardening</p> <p>Home Repair</p> | <p><u>Large Rats</u></p> <p>Exotic Pets Guide Lianne McLeod introduces you to the 30-inch long Gambian Giant Rat.</p> | <p><u>Decision</u></p> <p><u>2004</u></p> <p>With Wesley Clark officially in the race, U.S. Politics Guide Anne Linskey looks at all the candidates.</p> | <p><u>Malcolm X</u></p> <p>African-American History Guide Jessica McElrath tells us about the life of Malcolm X.</p> | <p>Search About</p> |
|---|--|--|---|----------------------------|

[About Us](#) | [Advertise on This Site](#) | [User Agreement](#) | [Privacy Policy](#) | [Kids' Privacy Policy](#) | [Help](#)

Copyright © [2003](#) About, Inc. About and About.com are registered trademarks of About, Inc. The About logo is a trademark of About, Inc. All rights reserved.



Landscaping

with [David Beaulieu](#)

Your Guide to one of [hundreds of sites](#)

[Home](#) · [Articles](#) · [Forums](#) · [Chat](#) · [Newsletters](#) · [Help](#)

Subjects

ESSENTIALS

- [Landscaping Glossary](#)
- [Landscape Solutions](#)
- [Landscaping 101](#)
- [Landscape Design for Beginners](#)
- [Landscaping FAQs](#)

BUYER'S GUIDE

- [Landscape Design](#)
- [Ornamental Trees](#)
- [Fall Foliage Trees](#)
- [Shrub Fall Colors](#)
- [Cheap Landscaping](#)
- [Easy Landscaping](#)
- [Landscape Plans](#)
- [Rock Gardens](#)
- [Patios, Walls](#)
- [Design for Birds](#)
- [Garden Pests](#)
- [Weed Control](#)
- [Bonsai, Japanese](#)
- [Shrubs, Bushes](#)
- [Decks and Arbors](#)
- [Links](#)

Landscaping 101: What is Landscape Design?

Part 3: Outdoor Lighting, Gardens and Principles of Landscape Design

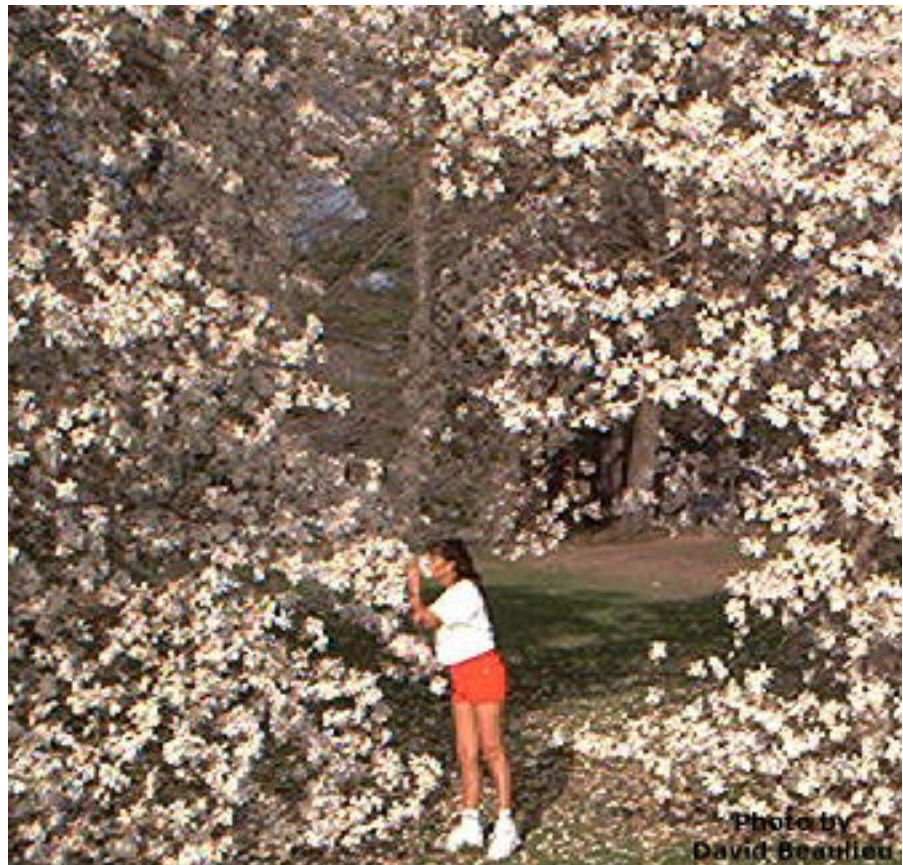

Magnolia trees are magnificent in the spring.

[Hedges, Fences](#)[Compost and Mulch](#)[Fruit Trees](#)[Ground Cover Vines](#)[Garden Accents](#)[Houseplants](#)[Pond, Water Garden](#)[Software, Hire Pro](#)[Soil, Fertilizer](#)[Rose Bushes](#)[Lawn Care](#)[Year-round Color](#)[Gift Ideas](#)[Top Picks](#)[Subject Library](#)[All articles on this topic](#)**Stay up-to-date!**

Subscribe to our newsletter.

Results About**New from About.com!**

[Get Paid to Improve Search](#)

Find Results Now:

[Feng Shui](#)

[Rolling Stones](#)

[Atkins Diet](#)

[Elvis Presley](#)

[Log Homes](#)

Outdoor lighting extends the time that you may appreciate hardscape and softscape features -- namely, into the night. Outdoor lighting becomes particularly important to landscape design in the winter. Not only are there fewer daylight hours in winter, but there is also inherently less visual interest on the landscape -- so you have to make the most of everything at your disposal. Picture a simple spruce tree, rising out of a blanket of snow, with a stone wall as a backdrop. By throwing a spotlight at night on this scene to highlight it, you create a winter wonderland.

Lawn or Garden?

Now that your structural elements are in place, it is time to turn your attention to the **softscape**. Typically, your softscape will include at least some **lawn**. The percentage of your landscape to be occupied by lawn will depend partly on practical considerations, as discussed in Part 1. But aesthetic attitudes play a part as well. If a flat expanse of grass just isn't inherently interesting enough for your tastes, you'll probably want flowering trees (see photo above) in your landscape design. And you'll certainly want to have a **garden** of some sort.

Gardens can take many forms:

- There are, of course, **vegetable** gardens. Do not underestimate the aesthetic potential of vegetable gardens. Evenly planted rows of leafy vegetables, for instance, can be very attractive. Cucumber plants can be trained up a trellis or over an arbor just as any other vine can.
- Another garden type that can yield aesthetic as well as culinary delights is the herb garden. The **knot garden**, pleasing to the eye for those who enjoy design patterns, is often composed of herbs.
- Cottage gardens typically rely heavily on perennial flowers. Evocative of the traditional English countryside of the peasants, cottage gardens represent the informal design style. For more on the historical debate between formal and informal landscape design camps, please consult [History of](#)

More of this Feature

- [Part 1: Definition of Landscape Design](#)
- [Part 2: Trees and Hardscape in Landscape Design](#)

Related Resources

- [Principles of Landscape Design](#)
- [Landscape Design FAQs](#)
- [History of Landscape Design](#)

Elsewhere on the Web

- [Landscape Design for Energy Conservation](#)
- [Energy Conservation Through Landscape Design](#)

Advertising

> [Free Credit Report](#)

Landscape Design.

- The formal landscape design style has traditionally relied heavily on shrubs tightly organized into hedges, forming geometric patterns.
- Water gardens have already been mentioned. Another garden type that relies heavily on a natural element *other than* plants is the rock garden, or alpine garden.
- Westerners have become increasingly interested in Japanese gardens. Japanese gardens rely heavily on both rocks and water, as well as wooden elements.

Principles of Landscape Design

Regardless of garden type, let yourself be guided by the principles of design developed by landscape design professionals. It is easy to overlook one or more of these principles, then look at someone else's landscape design and wonder, "Why does this look so much better than my landscape, even though similar plants have been used?" Very likely, the answer to this question lies in adherence to the principles of design. For a full treatment of landscape design principles, please consult [Landscape Design Theory for Beginners](#). The elements that underlie the principles of landscape design, which are defined in that article, are as follows:

- Color
- Form
- Line
- Scale
- Texture

Armed with an understanding of these elements, one is then able to utilize the principles of landscape design (also explained in [Landscape Design Theory for Beginners](#)), which include:

- Proportion
- Transition
- Unity
- Rhythm
- Balance
- Focalization

-- David Beaulieu

[Previous Articles](#)

Back to > [Introduction to Landscape Design](#) > Page [1](#), [2](#), [3](#)

[Email this page!](#)

Sponsored Links

[Distinctive Wild Bird and Garden Wildlife Products](#)

GardenBirds.com specializes in distinctive bird houses, bird feeders, bird baths and other products for garden wildlife. We have a free shipping offer and your satisfaction is guaranteed.

<http://www.GardenBirds.com/> [Sponsored Link](#)

[InsideSun Discount Garden Supplies](#)

InsideSun is your one-stop-shop for growing needs. Complete 400w HPS system only \$90. Huge discounts on MH too. Light systems and bulbs, hydroponics, nutrients, CO2, carbon scrubbers and more!

<http://www.insidesun.com/> [Sponsored Link](#)

[Home Harvest Garden Supply](#)

Fertilizers, compost, soil, discount seeds, greenhouses, nursery supplies, pest controls, pots, propagation, hydroponics, season extenders, grow lights and lots more at Home Harvest Garden Supply!

<http://homeharvest.com/> [Sponsored Link](#)

[Keep Your Home Safe - ADT](#)

Help protect your family and your home. Free security systems and free security reviews. Install a home security system from your local ADT Authorized Dealer. Find out more.

<http://www.KeepYourHomeSafe.com> [Sponsored Link](#)

[Home and Garden shopping at FurnitureFind.com!](#)

Browse a large selection of home and garden furnishings. Find quality, name brand furniture, save 30-50% and get free delivery! Call us today to take advantage of our free personal shopper service.

<http://www.furniturefind.com/> [Sponsored Link](#)

[Buy a Link Now!](#)

Explore More on the About Network!

| | | | | |
|--|---|--|---|---------------------|
| Related Sites Architecture Birding/Wild Birds Gardening Home Repair | <u>Large Rats</u> Exotic Pets Guide Lianne McLeod introduces you to the 30- inch long Gambian Giant Rat. | <u>Decision</u> <u>2004</u> With Wesley Clark officially in the race, U.S. Politics Guide Anne Linskey looks at all the candidates. | <u>Malcolm X</u> African- American History Guide Jessica McElrath tells us about the life of Malcolm X. | Search About |
|--|---|--|---|---------------------|

[About Us](#) | [Advertise on This Site](#) | [User Agreement](#) | [Privacy Policy](#) | [Kids' Privacy Policy](#) | [Help](#)

Copyright © [2003](#) About, Inc. About and About.com are registered trademarks of About, Inc. The About logo is a trademark of About, Inc. All rights reserved.



Landscaping

with [David Beaulieu](#)

Your Guide to one of [hundreds of sites](#)

[Home](#) · [Articles](#) · [Forums](#) · [Chat](#) · [Newsletters](#) · [Help](#)

Subjects

ESSENTIALS

- [Landscaping Glossary](#)
- [Landscape Solutions](#)
- [Landscaping 101](#)
- [Landscape Design for Beginners](#)
- [Landscaping FAQs](#)

BUYER'S GUIDE

- [Landscape Design](#)
- [Ornamental Trees](#)
- [Fall Foliage Trees](#)
- [Shrub Fall Colors](#)
- [Cheap Landscaping](#)
- [Easy Landscaping](#)
- [Landscape Plans](#)
- [Rock Gardens](#)
- [Patios, Walls](#)
- [Design for Birds](#)
- [Garden Pests](#)
- [Weed Control](#)
- [Bonsai, Japanese](#)
- [Shrubs, Bushes](#)
- [Decks and Arbors](#)
- [Links](#)

Easy Landscaping - Ideas, Tips, Advice

Guide picks

Okay, so you want a landscape worthy of Jerry Baker, "America's Master Gardener" but you want easy landscaping -- low maintenance landscaping? No mowing of lawn grass for you? Lawn mowing is not easy landscaping, you say? Advice, tips, ideas on easy landscaping, low maintenance lawn care, including tips from Jerry Baker.

[Building Lattice Screens: Easy Way to Hide Eyesores](#) New

Lattice screens are great for hiding elements on your landscape that you'd just as soon not put on display. Perhaps it's an unsightly HVAC unit, a garbage storage area, or deck supports. Whether you choose wood or vinyl, building lattice screens is a quick and easy way to improve the look of your landscape.

[Easy Stump Removal Without Using Stump Grinders](#)

Once you fell a tree, what do you do about the stump that remains? What are the options for removing tree stumps? Stump grinders make it easy but are expensive. You can also dig them out, but that's labor-intensive. Another cheap alternative is easy, to boot. Read about it here.

[Hedges, Fences](#)

[Compost and Mulch](#)

[Fruit Trees](#)

[Ground Cover Vines](#)

[Garden Accents](#)

[Houseplants](#)

[Pond, Water Garden](#)

[Software, Hire Pro](#)

[Soil, Fertilizer](#)

[Rose Bushes](#)

[Lawn Care](#)

[Year-round Color](#)

[Gift Ideas](#)

[Top Picks](#)

[Subject Library](#)

[All articles on this topic](#)

Stay up-to-date!

Subscribe to our newsletter.

ResultsAbout

New from About.com!

[Get Paid to Improve Search](#)

Find Results Now:

[Feng Shui](#)

[Rolling Stones](#)

[Atkins Diet](#)

[Elvis Presley](#)

[Log Homes](#)

[Easy Water Garden for Do-It-Yourselfers: Homemade Fountain](#)

This easy-to-build water fountain will provide your patio or other landscaping with a soothing sound. Free ideas for a low-maintenance water garden are laid out in a step-by-step tutorial for beginning do-it-yourselfers. Pictures included to illustrate these handy tips.

[Advice on Building an Easy, Do-It-Yourself Garden Arbor](#)

A garden arbor can serve as a landscaping focal point. Learn how to build an easy, cheap do it yourself garden arbor with the tips provided here. Article includes a free garden arbor plan, to make it easy for beginners to follow all the steps. Emphasis throughout the article is on the easiest way of doing everything: no carpentry skills are assumed.

[How to Build an Easy But Elegant Brick Patio](#)

Simple design plan to make laying brick patios easy for do it yourselfers. Brick patio design easy to build yet elegant, laying the bricks in a striking “basket weave” pattern that requires no cutting! Edging is also done in brick. Easy step by step instructions, including measurements, underlay, advice on tools. An easy hardscape project for do-it-yourselfer beginners.

[Tired of Mowing Grass Lawns: Clover's Easy Alternative](#)

What do clover lawns have over grass lawns? How about drought-tolerance, low-maintenance, cost-savings and environmental safety? Interested? Clover is insect-resistant and competes well with weeds, making it a low-maintenance substitute for grass. Mowing, watering and other lawn care is also reduced with clover. Clover is a boon to the lazy, saving time and energy.

Advertising

> [Free Credit Report](#)

Ratchet Anvil Hand Pruners for Easy Landscape Pruning

With “ratchet” anvil pruners it's easy to cut thick tree branches that regular pruners would stand no chance against. The ratchet settings multiply your hand's power, so that you don't have to do the work – the tool does it for you. As you cut through a branch, the ratchet clicks and moves to the next setting, providing ever-increasing pressure as you cut.

Book Review: Jerry Baker's "Plants Are Still Like People"

Famous for his 'home remedies' for plants, Baker is just as adept at offering chemical solutions. And he is not just a plant doctor, but also has a keen eye for what makes a landscape beautiful. Follow Baker's "Plants are like people" analogy from chapter to information-packed chapter as he sets us straight about lawns and gardens, trees and shrubs, annuals and perennials.

Pussy Willows: Easy to Grow on the Landscape

Great idea for the lazy: Pussy willows are easy to grow, and they're free! Discover their botany, easy incorporation into the landscape or garden, and minimal pruning requirements. Read these tips to make pussy willows a low maintenance alternative to store shrubs -- and a shortcut to making the lawn attractive in spring.

Xeriscaping: Landscaping for Drought

North America is beginning to realize that drought may be with us to stay. While this is bad news for lawns, it is a clarion call to experiment with other landscaping themes. In a word -- it is time to xeriscape.

1 [2](#) [Next](#)



[Email this page!](#)

Sponsored Links

[Distinctive Wild Bird and Garden Wildlife Products](#)

GardenBirds.com specializes in distinctive bird houses, bird feeders, bird baths and other products for garden wildlife. We have a free shipping offer and your satisfaction is guaranteed.

<http://www.GardenBirds.com/> [Sponsored Link](#)

[InsideSun Discount Garden Supplies](#)

InsideSun is your one-stop-shop for growing needs. Complete 400w HPS system only \$90. Huge discounts on MH too. Light systems and bulbs, hydroponics, nutrients, CO2, carbon scrubbers and more!

<http://www.insidesun.com/> [Sponsored Link](#)

[Home Harvest Garden Supply](#)

Fertilizers, compost, soil, discount seeds, greenhouses, nursery supplies, pest controls, pots, propagation, hydroponics, season extenders, grow lights and lots more at Home Harvest Garden Supply!

<http://homeharvest.com/> [Sponsored Link](#)

[Keep Your Home Safe - ADT](#)

Help protect your family and your home. Free security systems and free security reviews. Install a home security system from your local ADT Authorized Dealer. Find out more.

<http://www.KeepYourHomeSafe.com> [Sponsored Link](#)

[Home and Garden shopping at FurnitureFind.com!](#)

Browse a large selection of home and garden furnishings. Find quality, name brand furniture, save 30-50% and get free delivery! Call us today to take advantage of our free personal shopper service.

<http://www.furniturefind.com/> [Sponsored Link](#)

[Buy a Link Now!](#)

Explore More on the About Network!

| | | | | |
|--|--|--|--|---------------------|
| Related Sites Architecture Birding/Wild Birds Gardening Home Repair | Large Rats Exotic Pets Guide Lianne McLeod introduces you to the 30- inch long Gambian Giant Rat. | Decision 2004 With Wesley Clark officially in the race, U.S. Politics Guide Anne Linskey looks at all the candidates. | Malcolm X African- American History Guide Jessica McElrath tells us about the life of Malcolm X. | Search About |
|--|--|--|--|---------------------|

[About Us](#) | [Advertise on This Site](#) | [User Agreement](#) | [Privacy Policy](#) | [Kids' Privacy Policy](#) | [Help](#)

Copyright © [2003](#) About, Inc. About and About.com are registered trademarks of About, Inc. The About logo is a trademark of About, Inc. All rights reserved.



Landscaping

with [David Beaulieu](#)

Your Guide to one of [hundreds of sites](#)

[Home](#) · [Articles](#) · [Forums](#) · [Chat](#) · [Newsletters](#) · [Help](#)

Subjects

ESSENTIALS

- [Landscaping Glossary](#)
- [Landscape Solutions](#)
- [Landscaping 101](#)
- [Landscape Design for](#)

Beginners

- [Landscaping FAQs](#)

BUYER'S GUIDE

[Landscape Design](#)

[Ornamental Trees](#)

[Fall Foliage Trees](#)

[Shrub Fall Colors](#)

[Cheap Landscaping](#)

[Easy Landscaping](#)

[Landscape Plans](#)

[Rock Gardens](#)

[Patios, Walls](#)

[Design for Birds](#)

[Garden Pests](#)

[Weed Control](#)

[Bonsai, Japanese](#)

[Shrubs, Bushes](#)

[Decks and Arbors](#)

[Links](#)

[Hedges, Fences](#)

[Compost and Mulch](#)

[Fruit Trees](#)

[Ground Cover Vines](#)

[Garden Accents](#)

[Houseplants](#)

[Pond, Water Garden](#)

[Software, Hire Pro](#)

[Soil, Fertilizer](#)

[Rose Bushes](#)

Book: Jerry Baker's "Plants Are Still Like People"

Guide Review

Guide Rating - ★★★★★

- Pros**
- contains info not readily available elsewhere
 - provides numerous useful lists
 - each chapter ends with a practical Q&A

Cons • a bit preachy in places

The Bottom Line - Famous for his 'home remedies' for plants, Baker is just as adept at offering chemical solutions. And he is not just a plant doctor, but also has a keen eye for what makes a landscape beautiful.

[COMPARE PRICES](#)

Description

- Reading "germination labels" when buying grass seed: germination and purity should be close to 100%.
- Don't let blooms die on your shrubs: "a dying bloom takes too much from the rest of the plant."
- "Beating" your trees to make them grow better!
- In rooms where houseplants grow, paint walls bright colors: "These colors will reflect more light".
- Jerry's own fertilizer formula, which includes epsom salts, beer and soap.
- Measuring how deeply your lawn is being watered by a sprinkler: catch some of the water in a can.
- Bugs don't like their mouths washed out with soap any more than we -- use soap for bug control.
- Edging makes a garden "look neat and as though it were designed to fit into the overall landscape."
- A hole is not just a hole -- or 'how to plant trees properly.'
- Wear spiked shoes when you walk around on the lawn to aerate the soil.

Guide Review - Book: Jerry Baker's "Plants Are Still Like People"

The title is not only catchy, but reflects the contents. Baker is persistent with the premise that plants are like people, drawing one analogy after another. Take the chapter on lawns. Grass is compared to the hair on people's heads. Dethatching a lawn is like removing dandruff. Mowing is like going to the barber. But the book is not all fun and games: we are told why, when and how to mow, and when and how to water. We are, however, reminded in the same breath that grass is like people, in that "Grass can't swim," meaning too much watering will drown a lawn, depriving it of oxygen. And so it goes, chapter through chapter, whether on trees, shrubs or herbs, Baker shares his rich plant wisdom on an

- [Lawn Care](#)
- [Year-round Color](#)
- [Gift Ideas](#)
- [Top Picks](#)

[Subject Library](#)

[All articles on this topic](#)

Stay up-to-date!
Subscribe to our newsletter.

amusing framework of analogy.



~ [David Beaulieu](#)

Related Guide Picks

- [Book Review: BH&G on Landscaping](#)
- [Book Review: Landscaping for Dummies](#)

Related Resources

- [Frugal Landscaping](#)
- [Efficient Landscaping](#)
- [Indoor Landscaping](#)
- [Lawn Care](#)

[Important product disclaimer information about this About site.](#)

ResultsAbout

New from About.com!

[Get Paid to Improve Search](#)

Find Results Now:

- [Feng Shui](#)
- [Rolling Stones](#)
- [Atkins Diet](#)
- [Elvis Presley](#)
- [Log Homes](#)

[Email this page!](#)

Sponsored Links

[Distinctive Wild Bird and Garden Wildlife Products](#)

GardenBirds.com specializes in distinctive bird houses, bird feeders, bird baths and other products for garden wildlife. We have a free shipping offer and your satisfaction is guaranteed.

<http://www.GardenBirds.com/> [Sponsored Link](#)

[InsideSun Discount Garden Supplies](#)

InsideSun is your one-stop-shop for growing needs. Complete 400w HPS system only \$90. Huge discounts on MH too. Light systems and bulbs, hydroponics, nutrients, CO2, carbon scrubbers and more!

<http://www.insidesun.com/> [Sponsored Link](#)

[Home Harvest Garden Supply](#)

Fertilizers, compost, soil, discount seeds, greenhouses, nursery supplies, pest controls, pots, propagation, hydroponics, season extenders, grow lights and lots more at Home Harvest Garden Supply!

<http://homeharvest.com/> [Sponsored Link](#)

[Keep Your Home Safe - ADT](#)

Help protect your family and your home. Free security systems and free security reviews. Install a home security system from your local ADT Authorized Dealer. Find out more.

<http://www.keepyourhomesafe.com> [Sponsored Link](#)

[Home and Garden shopping at FurnitureFind.com!](#)

Browse a large selection of home and garden furnishings. Find quality, name brand furniture, save 30-50% and get free delivery! Call us today to take advantage of our free personal shopper service.

<http://www.furniturefind.com/> [Sponsored Link](#)

[Buy a Link Now!](#)

Explore More on the About Network!

| | | | | |
|--|---|--|--|----------------------------|
| <p>Related Sites</p> <ul style="list-style-type: none"> Architecture Birding/Wild Birds Gardening Home Repair | <p>Large Rats</p> <p>Exotic Pets Guide Lianne McLeod introduces you to the 30-inch long Gambian Giant Rat.</p> | <p>Decision 2004</p> <p>With Wesley Clark officially in the race, U.S. Politics Guide Anne Linskey looks at all the candidates.</p> | <p>Malcolm X</p> <p>African-American History Guide Jessica McElrath tells us about the life of Malcolm X.</p> | <p>Search About</p> |
|--|---|--|--|----------------------------|

[About Us](#) | [Advertise on This Site](#) | [User Agreement](#) | [Privacy Policy](#) | [Kids' Privacy Policy](#) | [Help](#)

Copyright © [2003](#) About, Inc. About and About.com are registered trademarks of About, Inc. The About logo is a trademark of About, Inc. All rights reserved.



Landscaping

with [David Beaulieu](#)

Your Guide to one of [hundreds of sites](#)

[Home](#) · [Articles](#) · [Forums](#) · [Chat](#) · [Newsletters](#) · [Help](#)

Subjects

ESSENTIALS

- [Landscaping Glossary](#)
- [Landscape Solutions](#)
- [Landscaping 101](#)
- [Landscape Design for Beginners](#)
- [Landscaping FAQs](#)

BUYER'S GUIDE

- [Landscape Design](#)
- [Ornamental Trees](#)
- [Fall Foliage Trees](#)
- [Shrub Fall Colors](#)
- [Cheap Landscaping](#)
- [Easy Landscaping](#)
- [Landscape Plans](#)
- [Rock Gardens](#)
- [Patios, Walls](#)
- [Design for Birds](#)
- [Garden Pests](#)
- [Weed Control](#)
- [Bonsai, Japanese](#)
- [Shrubs, Bushes](#)
- [Decks and Arbors](#)
- [Links](#)
- [Hedges, Fences](#)
- [Compost and Mulch](#)
- [Fruit Trees](#)
- [Ground Cover Vines](#)
- [Garden Accents](#)
- [Houseplants](#)
- [Pond, Water Garden](#)
- [Software, Hire Pro](#)
- [Soil, Fertilizer](#)
- [Rose Bushes](#)

How To Accomplish Tree Stump Removal Without Stump Grinders

A tree has been felled and its wood removed, but its stump still sits there, firmly rooted in the ground. What's the best way for removing tree stumps? Stump grinders can be rented but are expensive. Manual removal is cheap but has the drawback of being labor-intensive. Instead, I will focus on another cheap alternative that is also easy. But be forewarned: It requires some patience.



You can use a mattock for manual stump removal.
David Beaulieu

Difficulty: Easy
Time Required: 1 Hour

Here's How:

1. The first step is your decision on which technique to use. If you opt for manual removal of tree stumps, use a mattock. Its broad end allows you to dig around the stump; the other end functions as an axe for chopping your way through tree roots. Dig and chop your way under the rootball to the taproot. For large tree stumps, taproots may be large enough to require cutting with a full-size axe.
2. The rest of this article focuses on another technique, which is essentially a way to hasten the natural processes that would eventually break down the tree stump anyhow – even if you didn't lift a finger. But to hurry nature along, you'll be supplying 2 ingredients in unnatural quantities to speed up the rotting process: nitrogen and water.
3. But first, using a chain saw, cut the stump down as close to the ground as you can, without allowing the chain saw's teeth to strike the ground (this would dull your chain).
4. Drill holes a few inches deep into the tree stump in numerous places, using your widest drill bit. The wider and deeper the holes, the better.
5. Fill these holes first with water, then with a fertilizer high in nitrogen. For instance, you could use cow manure. If you're using a commercial fertilizer instead, make sure the first of the 3 numbers of the fertilizer's NPK is the highest (for instance, a straight nitrogen fertilizer such as 45-0-0).
6. Soak the ground all around the tree stump. Cover the tree stump with a plastic tarp. The tarp will act as a barrier to help retain

[Lawn Care](#)

[Year-round Color](#)

[Gift Ideas](#)

[Top Picks](#)

[Subject Library](#)

[All articles on this topic](#)

Stay up-to-date!

Subscribe to our newsletter.

Results About

New from About.com!

[Get Paid to Improve Search](#)

Find Results Now:

[Feng Shui](#)

[Rolling Stones](#)

[Atkins Diet](#)

[Elvis Presley](#)

[Log Homes](#)

Advertising

> [Free Credit Report](#)

moisture in and around the tree stump.

7. Apply an organic mulch over the plastic tarp, and water it thoroughly. An organic mulch, such as tree bark or hay, will hold additional moisture, keeping the area even wetter. Wet mulch is also heavy, which will help weigh the tarp down, so that it doesn't blow away. For additional weight, roll some heavy stones onto the tarp.
8. The final thing you need to do for this project is -- to be patient! You're speeding up the natural process of rotting by employing the steps above, but this technique is still not for those who need stump removal N-O-W.
9. You'll reduce your wait, however, by periodically removing the mulch and tarp for a moment and once again thoroughly soaking the tree stump and the ground around it. If you still have that nitrogen source at your disposal, add more of it. Then reapply the plastic tarp and mulch. Soak the mulch again, too.

Tips:

1. There is a product called, "Stump Remover" that breaks down the wood fiber of tree stumps, leaving them porous. The porous wood then absorbs kerosene readily. After the porous wood is soaked with kerosene and ignited, it will burn away. The flame is a low, smoldering flame. If the use of kerosene and flame is acceptable to you, this is another cheap and easy option.

What You Need:

- chain saw
- plastic tarp
- mulch
- high-nitrogen fertilizer
- drill
- (mattock)
- (axe)

[More How To's from your Guide To Landscaping](#)

~ [David Beaulieu](#)

Related Resources

- [Renting Stump Grinders](#)
- [Understanding a Fertilizer's NPK](#)
- [All About Mulches](#)

[Email this page!](#)

Sponsored Links

Distinctive Wild Bird and Garden Wildlife Products

GardenBirds.com specializes in distinctive bird houses, bird feeders, bird baths and other products for garden wildlife. We have a free shipping offer and your satisfaction is guaranteed.

<http://www.GardenBirds.com/> [Sponsored Link](#)

InsideSun Discount Garden Supplies

InsideSun is your one-stop-shop for growing needs. Complete 400w HPS system only \$90. Huge discounts on MH too. Light systems and bulbs, hydroponics, nutrients, CO2, carbon scrubbers and more!

<http://www.insidesun.com/> [Sponsored Link](#)

Home Harvest Garden Supply

Fertilizers, compost, soil, discount seeds, greenhouses, nursery supplies, pest controls, pots, propagation, hydroponics, season extenders, grow lights and lots more at Home Harvest Garden Supply!

<http://homeharvest.com/> [Sponsored Link](#)

Keep Your Home Safe - ADT

Help protect your family and your home. Free security systems and free security reviews. Install a home security system from your local ADT Authorized Dealer. Find out more.

<http://www.keepyourhomesafe.com> [Sponsored Link](#)

Home and Garden shopping at FurnitureFind.com!

Browse a large selection of home and garden furnishings. Find quality, name brand furniture, save 30-50% and get free delivery! Call us today to take advantage of our free personal shopper service.

<http://www.furniturefind.com/> [Sponsored Link](#)

Buy a Link Now!

Explore More on the About Network!

| | | | | |
|---|--|---|---|----------------------------|
| <p>Related Sites</p> <p>Architecture Birding/Wild Birds Gardening Home Repair</p> | <p><u>Large Rats</u></p> <p>Exotic Pets Guide Lianne McLeod introduces you to the 30-inch long Gambian Giant Rat.</p> | <p><u>Decision 2004</u></p> <p>With Wesley Clark officially in the race, U.S. Politics Guide Anne Linskey looks at all the candidates.</p> | <p><u>Malcolm X</u></p> <p>African-American History Guide Jessica McElrath tells us about the life of Malcolm X.</p> | <p>Search About</p> |
|---|--|---|---|----------------------------|

[About Us](#) | [Advertise on This Site](#) | [User Agreement](#) | [Privacy Policy](#) | [Kids' Privacy Policy](#) | [Help](#)

Copyright © 2003 About, Inc. About and About.com are registered trademarks of About, Inc. The About logo is a trademark of About, Inc. All rights reserved.



Landscaping

with [David Beaulieu](#)

Your Guide to one of [hundreds of sites](#)

[Home](#) · [Articles](#) · [Forums](#) · [Chat](#) · [Newsletters](#) · [Help](#)

Subjects

ESSENTIALS

- [Landscaping Glossary](#)
- [Landscape Solutions](#)
- [Landscaping 101](#)
- [Landscape Design for Beginners](#)
- [Landscaping FAQs](#)

BUYER'S GUIDE

- [Landscape Design](#)
- [Ornamental Trees](#)
- [Fall Foliage Trees](#)
- [Shrub Fall Colors](#)
- [Cheap Landscaping](#)
- [Easy Landscaping](#)
- [Landscape Plans](#)
- [Rock Gardens](#)
- [Patios, Walls](#)
- [Design for Birds](#)
- [Garden Pests](#)
- [Weed Control](#)
- [Bonsai, Japanese](#)
- [Shrubs, Bushes](#)
- [Decks and Arbors](#)
- [Links](#)
- [Hedges, Fences](#)
- [Compost and Mulch](#)
- [Fruit Trees](#)
- [Ground Cover Vines](#)
- [Garden Accents](#)
- [Houseplants](#)

How To Build an Elegant Brick Patio Without Brick-Cutting

A simple design plan to make laying brick patios easy for do-it-yourselfers. This brick patio design is easy to build yet elegant, laying the bricks in a striking pattern that requires no cutting!

Difficulty: Average

Time Required: 2 days for a small patio

Here's How:

1. Measure out the desired area. Rectangular design plans are easier to execute than curved designs. To ensure that you have a perfect rectangle, measure the 2 diagonals: they should be of equal length.
2. Dig out the area, to a depth of 8". With a level, check that your excavation's floor slopes (1/4" per running foot) away from the house for drainage, so water will run away from the house and patio.
3. Do a test run by laying your brick pattern, to check your measurements. This way, if your initial measurement was off, you can correct it now. There should be about 2" extra all along the perimeter.
4. This extra 2" along the perimeter is for the insertion of brick edging (the bricks are about 2" thick). Stand the bricks on end, "shoulder to shoulder." Tap them into place with a rubber mallet.
5. The idea in Step #4 is to frame the rectangular area. Remove the bricks that you laid as a test run. Pour crushed stone into this framed area, to a depth of 4".
6. Tamp down the stone. Lay landscape fabric down over the stone, to suppress potential weeds later. Now pour 2" of sand over the landscape fabric. Use a long 2x4 as a screed (see link #1 below).
7. Starting at one end of the rectangle, run this screed along the sand, leveling the sand out. You want the sand's level to end up 2" below the tops of the edging bricks.
8. Excess sand in Step #7 will thus be redistributed to low

[Pond, Water Garden](#)

[Software, Hire Pro](#)

[Soil, Fertilizer](#)

[Rose Bushes](#)

[Lawn Care](#)

[Year-round Color](#)

[Gift Ideas](#)

[Top Picks](#)

[Subject Library](#)

[All articles on this topic](#)

Stay up-to-date!

Subscribe to our newsletter.

ResultsAbout

New from About.com!

[Get Paid to Improve Search](#)

Find Results Now:

[Feng Shui](#)

[Rolling Stones](#)

[Atkins Diet](#)

[Elvis Presley](#)

[Log Homes](#)

Advertising

> [Free Credit Report](#)

areas, and you'll end up with an even surface. Tamp the sand down. Now it's time to begin laying the brick patio flooring -- for real!

9. Begin in a corner, pressing the bricks down into the sand. Make them abut as closely together as possible. Strike the bricks with a rubber mallet to settle them into the sand.
10. You want "paving" bricks for this project. In the measurements that I'm giving, I'm assuming 4" x 8" bricks, about 2" thick. Brick pavers come in other sizes; but this size is easiest to work with.
11. For a design pattern, I'm suggesting the "basket weave" (see link #2 below, which links to an illustration of the basket weave design pattern).
12. The basket weave pattern is elegant yet simple, requiring no cutting of bricks. Avoiding cutting will save you in time, money and frustration!
13. Run a mason's line across your forms as you proceed, row by row, in laying your bricks. The mason's line will serve as a guide for evenness.
14. After laying the bricks, spread some sand over them. With a broom, work this sand into the cracks. Then, with a garden hose, gently spray the bricks, so the sand will settle between the cracks.
15. If the cracks still aren't totally filled, repeat Step #14. Now you're done!

Tips:

1. For a graphic illustration of the basket weave design pattern see [the basket weave page](#). This is an attractive flooring design, without any brick-cutting.
2. The key to keeping the project pressure-free is Step #3. For the mathematically-challenged, it's comforting to know -- ahead of time -- that all the bricks will fit within the frame, and fit tightly.
3. As you lay bricks (Steps #9 - #13), kneel neither on the sand nor directly on the bricks. Kneel instead on plywood atop the bricks. You don't want to make the sand uneven or dislodge the bricks.
4. Rectangular plans work best for small patios. To soften the rigid lines, simply plant container gardens along the edges. For larger patios, consider curved designs -- but be ready to cut bricks!
5. A brick that's 4x8x2 makes this project go more smoothly: in a basket weave design you want the widths of 2 bricks to equal the length of 1, so that you can develop a clean checkerboard pattern.

What You Need:

- shovel and rubber mallet
- level
- crushed stone
- landscape fabric
- paving bricks
- mason's line
- plywood to kneel on
- broom
- garden hose
- one long 2x4 for screed

[More How To's from your Guide To Landscaping](#)

~ [David Beaulieu](#)

Related Resources

- [Definition of Screed](#)
- [Illustration: Basket Weave](#)
- [How to Build Concrete Patios](#)
- [Architecture Guide: Build a Brick Patio](#)

[Email this page!](#)

Sponsored Links

[Distinctive Wild Bird and Garden Wildlife Products](#)

GardenBirds.com specializes in distinctive bird houses, bird feeders, bird baths and other products for garden wildlife. We have a free shipping offer and your satisfaction is guaranteed.

<http://www.GardenBirds.com/> [Sponsored Link](#)

[InsideSun Discount Garden Supplies](#)

InsideSun is your one-stop-shop for growing needs. Complete 400w HPS system only \$90. Huge discounts on MH too. Light systems and bulbs, hydroponics, nutrients, CO2, carbon scrubbers and more!

<http://www.insidesun.com/> [Sponsored Link](#)

[Home Harvest Garden Supply](#)

Fertilizers, compost, soil, discount seeds, greenhouses, nursery supplies, pest controls, pots, propagation, hydroponics, season extenders, grow lights and lots more at Home Harvest Garden Supply!

<http://homeharvest.com/> [Sponsored Link](#)

[Keep Your Home Safe - ADT](#)

Help protect your family and your home. Free security systems and free security reviews.

Install a home security system from your local ADT Authorized Dealer. Find out more.

<http://www.KeepYourHomeSafe.com> [Sponsored Link](#)

[Home and Garden shopping at FurnitureFind.com!](#)

Browse a large selection of home and garden furnishings. Find quality, name brand furniture, save 30-50% and get free delivery! Call us today to take advantage of our free personal shopper service.

<http://www.furniturefind.com/> [Sponsored Link](#)

[Buy a Link Now!](#)

Explore More on the About Network!

| | | | | |
|--|---|--|--|---------------------|
| Related Sites Architecture Birding/Wild Birds Gardening Home Repair | Large Rats Exotic Pets Guide Lianne McLeod introduces you to the 30-inch long Gambian Giant Rat. | Decision 2004 With Wesley Clark officially in the race, U.S. Politics Guide Anne Linskey looks at all the candidates. | Malcolm X African-American History Guide Jessica McElrath tells us about the life of Malcolm X. | Search About |
|--|---|--|--|---------------------|

[About Us](#) | [Advertise on This Site](#) | [User Agreement](#) | [Privacy Policy](#) | [Kids' Privacy Policy](#) | [Help](#)

Copyright © 2003 About, Inc. About and About.com are registered trademarks of About, Inc. The About logo is a trademark of About, Inc. All rights reserved.



Landscaping

with [David Beaulieu](#)

Your Guide to one of [hundreds of sites](#)

[Home](#) · [Articles](#) · [Forums](#) · [Chat](#) · [Newsletters](#) · [Help](#)

Subjects

ESSENTIALS

- [Landscaping Glossary](#)
- [Landscape Solutions](#)
- [Landscaping 101](#)
- [Landscape Design for Beginners](#)
- [Landscaping FAQs](#)

BUYER'S GUIDE

- [Landscape Design](#)
- [Ornamental Trees](#)
- [Fall Foliage Trees](#)
- [Shrub Fall Colors](#)
- [Cheap Landscaping](#)
- [Easy Landscaping](#)
- [Landscape Plans](#)
- [Rock Gardens](#)
- [Patios, Walls](#)
- [Design for Birds](#)
- [Garden Pests](#)
- [Weed Control](#)
- [Bonsai, Japanese](#)
- [Shrubs, Bushes](#)
- [Decks and Arbors](#)
- [Links](#)

Landscape Design Plans

Guide picks

These resources discuss landscape design plans. See how professional landscape designers sketch out their design themes before implementing them.

[Free Landscape Design Plan: The Deer-Proof Border](#)

This free landscape plan will show you how to design a border of deer-resistant plants. The landscaping plan is supplemented by descriptions of the plants appropriate for your deer-proof border. Tips included on how to draw plans of your own. Simply download and print out the free landscape design plan, or just follow the plan online while reading the descriptions.

[Free Landscaping Plan: How to Design and Build Garden Arbors](#)

Free garden arbor plan, supplemented by photos and descriptions. Step-by-step instructions for landscaping beginners seeking to build a wooden garden arbor. The free wooden arbor plan is designed for the beginning do-it-yourselfer: it's easy to follow and implement. Tips accompany this free landscape design plan showing how to keep the project as simple as possible.

[Landscape Design Ideas for Selling Your Property](#)

[Hedges, Fences](#)
[Compost and Mulch](#)
[Fruit Trees](#)
[Ground Cover Vines](#)
[Garden Accents](#)
[Houseplants](#)
[Pond, Water Garden](#)
[Software, Hire Pro](#)
[Soil, Fertilizer](#)
[Rose Bushes](#)
[Lawn Care](#)
[Year-round Color](#)
[Gift Ideas](#)
[Top Picks](#)

[Subject Library](#)

[All articles on this topic](#)

Stay up-to-date!

Subscribe to our newsletter.

ResultsAbout

New from About.com!

[Get Paid to Improve Search](#)

Find Results Now:

[Feng Shui](#)
[Rolling Stones](#)
[Atkins Diet](#)
[Elvis Presley](#)
[Log Homes](#)

When you're designing a landscape that will be going on the real estate market, you're designing for someone else's tastes -- the buyer's -- not your own. You need ideas about what buyers are currently looking for. You'll get those design ideas in this article, plus advice on exploiting other sources for design ideas.

Landscape Design Theory for Beginners

Outdoor aesthetics 101. A practical introduction to the principles of landscape design architecture, as well as the basic elements upon which they are grounded. Emphasis on softscape features. Some topics: unity (harmony), colors, focalization, perspectives, textures, forms, massing, repetitions, balance, symmetry.

Review: "Landscaping for Dummies" Book

The "Dummies" people have done it again! A comprehensive book designed for the beginner. You'll find yourself consulting specific topics again and again if you place this book on your bookshelf. The book also provides links to useful landscaping URLs and sources for hiring professionals.

Landscaping 101 - What is Landscaping?

Definition of landscape design for the do it yourselfer. Energy conservation, hardscape and softscape are the overarching themes. The softscape discussion focuses on the various kinds of gardens to be used for landscape enhancement.

Sketching a Hummingbird Landscape Plan: Plant Options

Selecting plants for a hummingbird landscape plan, with an eye to both general landscape design and attracting the birds. Sketching a rough plan will help remind us what jobs need to be done first: hardscape and "heavy" softscape elements, namely.

Advertising

> [Free Credit Report](#)

Having a plan will also allow for calculations to "get it right" in installing arbors, patios, etc. for maximum landscape enjoyment.

[A Garden Design Introduction](#)

Deborah Simpson's primer on garden design. Function, practicality and comfort are emphasized. Included is sound advice on when the services of a professional might be required. Planning by means of a "relationship diagram" is discussed.

[How To Draw a Landscape Plan: Part I](#)

A very detailed presentation from Texas A&M. Examples of plans provided. This resource even provides the symbols commonly used by professional landscape architects to in drawing up their design plans.

[How to Draw a Landscape Plan: Part II](#)

Part II of the Texas A&M Extension's detailed instructions on planning a landscape. Tracing paper is placed over the plan drawn in Part I, and sketches are made delineating areas of the landscape, based on needs. The five areas used as examples are for: work or service; recreation or active sports; outdoor living and entertaining; public and entrance; and children's activities.

1 [2](#) [Next](#)

[Email this page!](#)

Sponsored Links

[Distinctive Wild Bird and Garden Wildlife Products](#)

GardenBirds.com specializes in distinctive bird houses, bird feeders, bird baths and other products for garden wildlife. We have a free shipping offer and your satisfaction is guaranteed.

<http://www.GardenBirds.com/> [Sponsored Link](#)

[InsideSun Discount Garden Supplies](#)

InsideSun is your one-stop-shop for growing needs. Complete 400w HPS system only \$90. Huge discounts on MH too. Light systems and bulbs, hydroponics, nutrients, CO2, carbon scrubbers and more!

<http://www.insidesun.com/> [Sponsored Link](#)

[Home Harvest Garden Supply](#)

Fertilizers, compost, soil, discount seeds, greenhouses, nursery supplies, pest controls, pots, propagation, hydroponics, season extenders, grow lights and lots more at Home Harvest Garden Supply!

<http://homeharvest.com/> [Sponsored Link](#)

[Keep Your Home Safe - ADT](#)

Help protect your family and your home. Free security systems and free security reviews. Install a home security system from your local ADT Authorized Dealer. Find out more.

<http://www.KeepYourHomeSafe.com> [Sponsored Link](#)

[Home and Garden shopping at FurnitureFind.com!](#)

Browse a large selection of home and garden furnishings. Find quality, name brand furniture, save 30-50% and get free delivery! Call us today to take advantage of our free personal shopper service.

<http://www.furniturefind.com/> [Sponsored Link](#)

[Buy a Link Now!](#)

Explore More on the About Network!

| | | | | |
|---|--|---|---|----------------------------|
| <p>Related Sites</p> <p>Architecture</p> <p>Birding/Wild Birds</p> <p>Gardening</p> <p>Home Repair</p> | <p><u>Large Rats</u></p> <p>Exotic Pets Guide Lianne McLeod introduces you to the 30-inch long Gambian Giant Rat.</p> | <p><u>Decision</u></p> <p>2004</p> <p>With Wesley Clark officially in the race, U.S. Politics Guide Anne Linskey looks at all the candidates.</p> | <p><u>Malcolm X</u></p> <p>African-American History Guide Jessica McElrath tells us about the life of Malcolm X.</p> | <p>Search About</p> |
|---|--|---|---|----------------------------|

[About Us](#) | [Advertise on This Site](#) | [User Agreement](#) | [Privacy Policy](#) | [Kids' Privacy Policy](#) | [Help](#)

Copyright © 2003 About, Inc. About and About.com are registered trademarks of About, Inc. The About logo is a trademark of About, Inc. All rights reserved.



Landscaping

with [David Beaulieu](#)

Your Guide to one of [hundreds of sites](#)

[Home](#) · [Articles](#) · [Forums](#) · [Chat](#) · [Newsletters](#) · [Help](#)

Subjects

ESSENTIALS

- [Landscaping Glossary](#)
- [Landscape Solutions](#)
- [Landscaping 101](#)
- [Landscape Design for Beginners](#)
- [Landscaping FAQs](#)

BUYER'S GUIDE

- [Landscape Design](#)
- [Ornamental Trees](#)
- [Fall Foliage Trees](#)
- [Shrub Fall Colors](#)
- [Cheap Landscaping](#)
- [Easy Landscaping](#)
- [Landscape Plans](#)
- [Rock Gardens](#)
- [Patios, Walls](#)
- [Design for Birds](#)
- [Garden Pests](#)
- [Weed Control](#)
- [Bonsai, Japanese](#)
- [Shrubs, Bushes](#)
- [Decks and Arbors](#)
- [Links](#)
- [Hedges, Fences](#)
- [Compost and Mulch](#)
- [Fruit Trees](#)
- [Ground Cover Vines](#)
- [Garden Accents](#)
- [Houseplants](#)
- [Pond, Water Garden](#)
- [Software, Hire Pro](#)
- [Soil, Fertilizer](#)
- [Rose Bushes](#)
- [Lawn Care](#)

Landscaping Made Easy With "Landscaping for Dummies"

Guide Review

Guide Rating - ★★★★★

Pros

- Truly written for the novice...
- yet comprehensive...
- and all at the right price!

Cons

- Relatively few color photos.

The Bottom Line - This is the book I'd want on my bookshelf as a novice to landscaping who just bought a new home. As with all "Dummies" books, either read straight through starting at Page 1, or use as a reference.

[COMPARE PRICES](#)

Description

- Plant naming conventions explained. We're told what the funny Latin terminology is there for.
- Tip for drawing a site plan: "form follows function." Don't plant shrubs on an athlete's lawn.
- Tips on saving money, zoning, construction and do-it-yourself tasks vs. tasks for professionals.
- Hardscape tips: fences, patios, decks, gates, walls, paths. Concrete work, brick, pavers, stone.
- Tip: hardscape precedes softscape. Remembering this will save you time, money and frustration.
- How to tackle problem areas. For instance, converting a slope into a showcase area.
- Using a hedge as a privacy screen? Find out the best plant choices for your needs.
- Sod vs. seed for planting a lawn, and about ground covers and native plantings instead of lawns.
- Theme gardens, drought-tolerant plants, woodland gardens, water gardens and rock gardens.
- Using raised beds in landscaping to eliminate backache and provide interest on the vertical plane.

[Year-round Color](#)

[Gift Ideas](#)

[Top Picks](#)

[Subject Library](#)

[All articles on this topic](#)

Stay up-to-date!

Subscribe to our newsletter.

Results About

New from About.com!

Get Paid to Improve Search

Find Results Now:

[Feng Shui](#)

[Rolling Stones](#)

[Atkins Diet](#)

[Elvis Presley](#)

[Log Homes](#)

Advertising

> [Free Credit Report](#)

Guide Review - Landscaping Made Easy With "Landscaping for Dummies"

"A well-planned landscape beautifies your house, wedding it with the surroundings and making it a part of a neighborhood or native terrain." My opinion of this quote from the Introduction could just as easily serve as my opinion of the whole book -- comprehensive yet simple. As with all "Dummies" books, it's packed with information from the outset, giving landscaping URLs and sources for hiring professionals in the Preface. Divided into 5 sections, it begins with how to draw a site plan. There follow sections on hardscape, softscape and site plans fully drawn by professionals. Finally, as is the Dummies tradition, it closes with "The Part of Tens," most notably with "Ten Ways to Increase Your Home's Resale Value."

[COMPARE PRICES](#)

~ [David Beaulieu](#)

Related Guide Picks

- [Better Homes and Gardens on Landscaping](#)
- [Jerry Baker's "Plants Are Like People"](#)

Related Resources

- [Landscape Design for Beginners](#)
- [Landscape Design Examples](#)
- [Landscape Design Site Plans](#)
- [Hiring Professionals for Landscaping](#)

Important product disclaimer information about this About site.

[Email this page!](#)

Sponsored Links

[Distinctive Wild Bird and Garden Wildlife Products](#)

GardenBirds.com specializes in distinctive bird houses, bird feeders, bird baths and other products for garden wildlife. We have a free shipping offer and your satisfaction is guaranteed.

<http://www.GardenBirds.com/> [Sponsored Link](#)

[InsideSun Discount Garden Supplies](#)

InsideSun is your one-stop-shop for growing needs. Complete 400w HPS system only \$90. Huge discounts on MH too. Light systems and bulbs, hydroponics, nutrients, CO2, carbon scrubbers and more!

<http://www.insidesun.com/> [Sponsored Link](#)

[Home Harvest Garden Supply](#)

Fertilizers, compost, soil, discount seeds, greenhouses, nursery supplies, pest controls, pots, propagation, hydroponics, season extenders, grow lights and lots more at Home Harvest Garden Supply!

<http://homeharvest.com/> [Sponsored Link](#)

[Keep Your Home Safe - ADT](#)

Help protect your family and your home. Free security systems and free security reviews. Install a home security system from your local ADT Authorized Dealer. Find out more.

<http://www.keepyourhomesafe.com> [Sponsored Link](#)

[Home and Garden shopping at FurnitureFind.com!](#)

Browse a large selection of home and garden furnishings. Find quality, name brand furniture, save 30-50%

and get free delivery! Call us today to take advantage of our free personal shopper service.

<http://www.furniturefind.com/> [Sponsored Link](#)

[Buy a Link Now!](#)

Explore More on the About Network!

| | | | | |
|--|--|--|--|---------------------|
| Related Sites Architecture Birding/Wild Birds Gardening Home Repair | <u>Large Rats</u> Exotic Pets Guide Lianne McLeod introduces you to the 30-inch long Gambian Giant Rat. | <u>Decision 2004</u> With Wesley Clark officially in the race, U.S. Politics Guide Anne Linskey looks at all the candidates. | <u>Malcolm X</u> African-American History Guide Jessica McElrath tells us about the life of Malcolm X. | Search About |
|--|--|--|--|---------------------|

[About Us](#) | [Advertise on This Site](#) | [User Agreement](#) | [Privacy Policy](#) | [Kids' Privacy Policy](#) | [Help](#)

Copyright © 2003 About, Inc. About and About.com are registered trademarks of About, Inc. The About logo is a trademark of About, Inc. All rights reserved.

Base Plan

Draw a base plan to scale. For most properties a scale of 1/8"=1' is workable; for small properties or a particular area of a larger development 1/4"=1' may be better. Graph paper with lines indicating a particular scale may also be helpful. Include all major features on your drawing such as existing walks, terraces, outbuildings, trees, shrubs, drives, property lines, easements, utilities, etc. After preparing the base plan, place tracing paper or tissue paper over the original plan to sketch possible ideas and solutions to your landscape needs and problems.

SUGGESTED SYMBOLS

| | |
|--|--|
| <p>——— PROPERTY LINE</p> <p>----- CITY EASEMENT</p> <p>——— SEWER LINE</p> <p>..... ELECTRIC LINE</p> <p>----- WATER LINE</p> <p>◆ TELEPHONE POLE</p> | <p>+ WATER SPIGOT</p> <p>⊞ GAS METER</p> <p>⊞ WATER METER</p> <p>⊞ FIRE HYDRANT</p> <p>⊞ AIR CONDITIONING UNIT</p> |
|--|--|

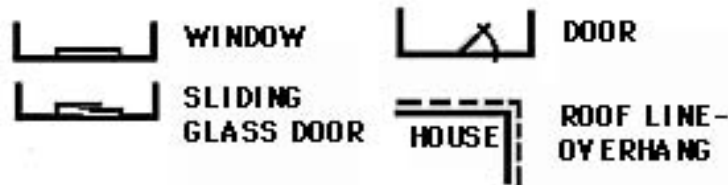

Steps for Drawing a Base Plan

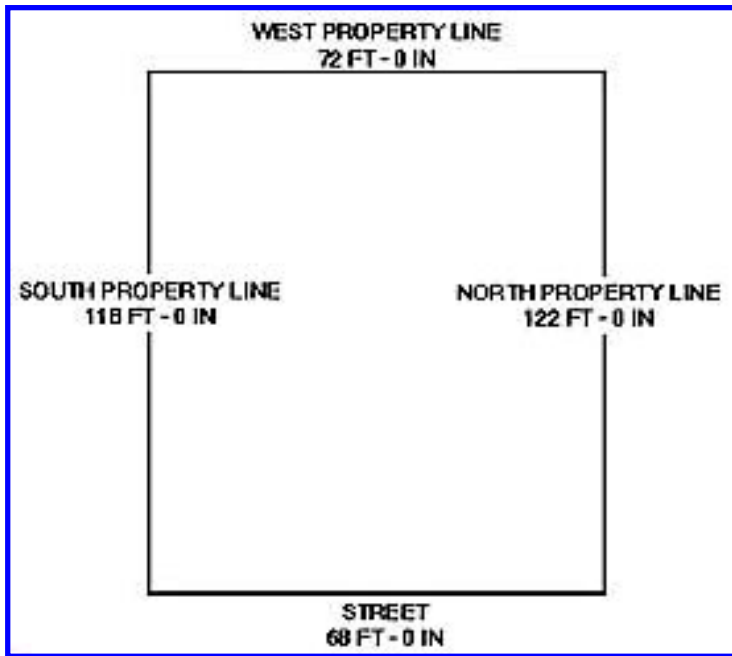

Step One

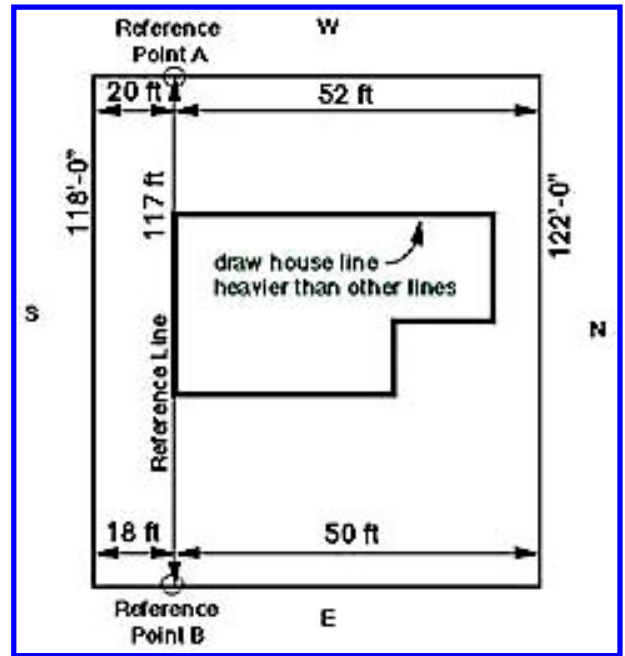

Step Two

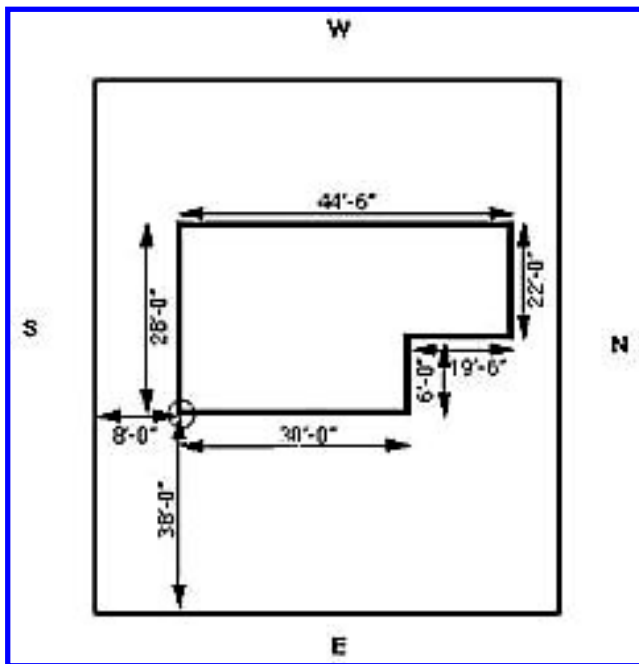

Step Three

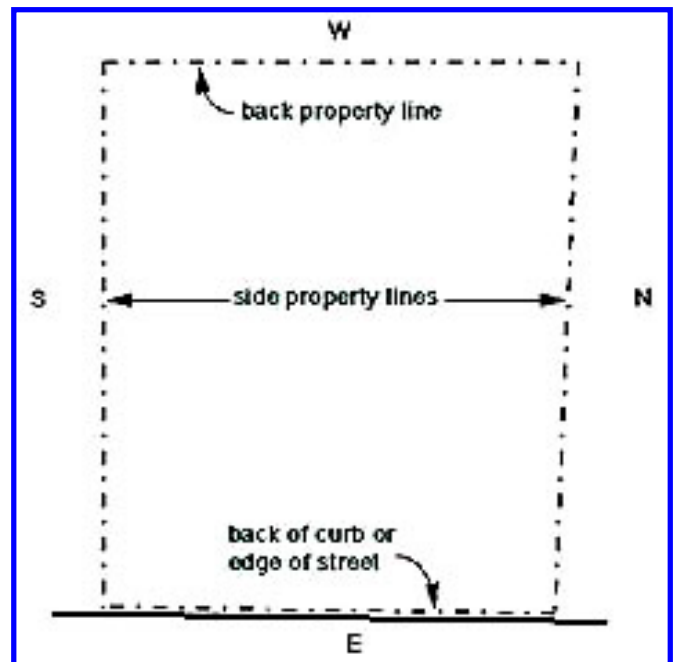

Step Four

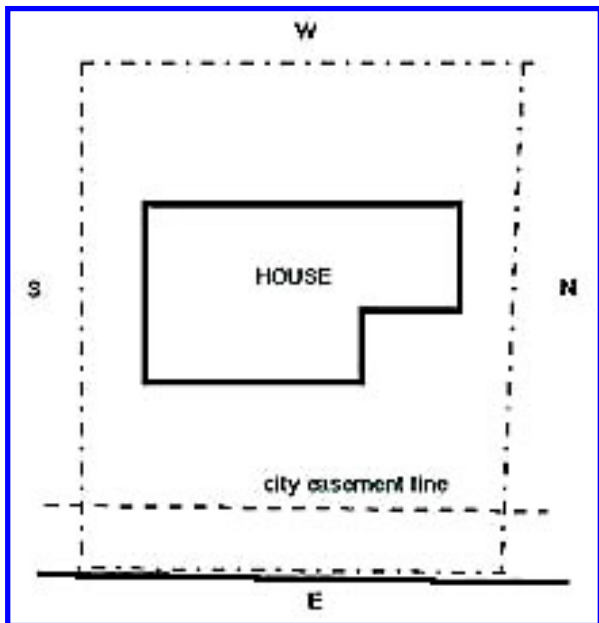

Step Five

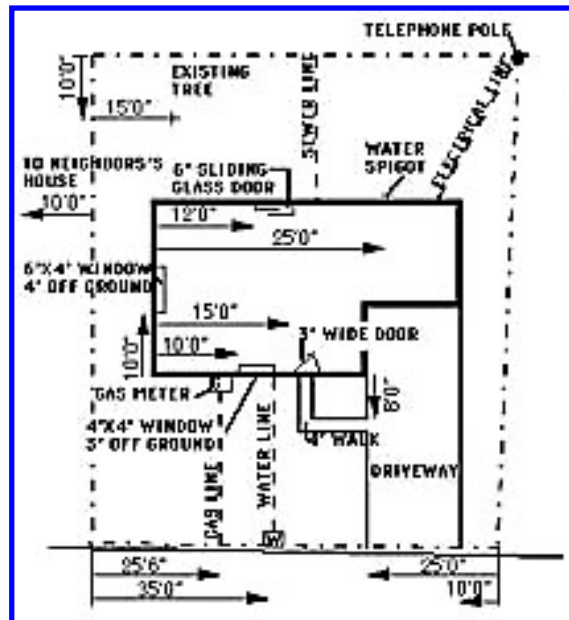

Step Six

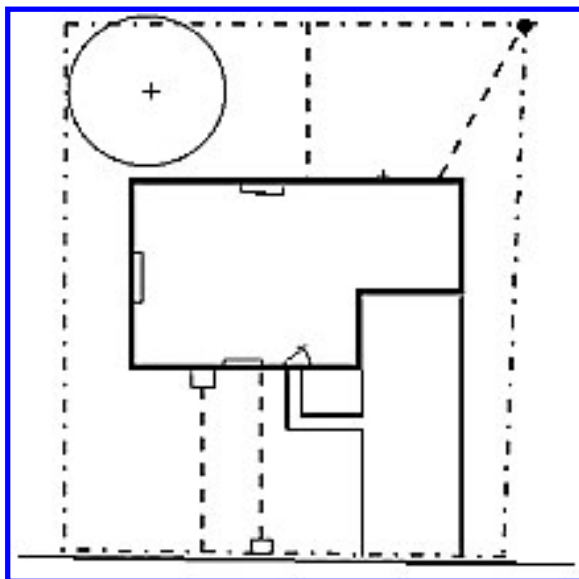

Step Seven

Always indicate compass directions in relation to the house by drawing an arrow (N->) pointing north. You may also want to show the direction of the rising sun. In winter, the sun rises a little south of east and sets a little south of west. In summer, the sun rises somewhat north of east and sets somewhat north of west.

SEASONAL SUN ANGLES WHICH WILL AFFECT THE DESIGN OF THE LANDSCAPE

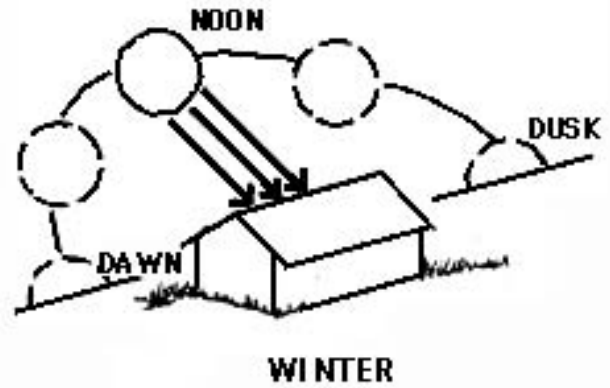
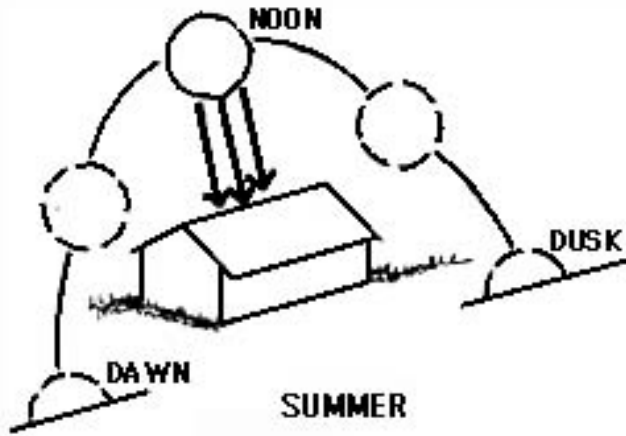

[Home](#) | [Needs](#) | [Site](#) | [Diagram](#) | [Materials](#) | [Plants](#) | [Landscape Construction](#) | [Accessories](#) |

- Back to the Topic Site
- Turn off this top frame

Diagram

Diagram and place space needs. Again, tape tracing paper over your plot plan and go back to your list of needs from step two. Place needs and activities where they can serve best and provide enough space for each need. (For example: and outdoor living area should be of sufficient size for the use it will receive.) Rather than decide upon the shape of a lawn, terrace or parking area at the beginning, let these forms develop from and reflect the needs listed in the beginning.

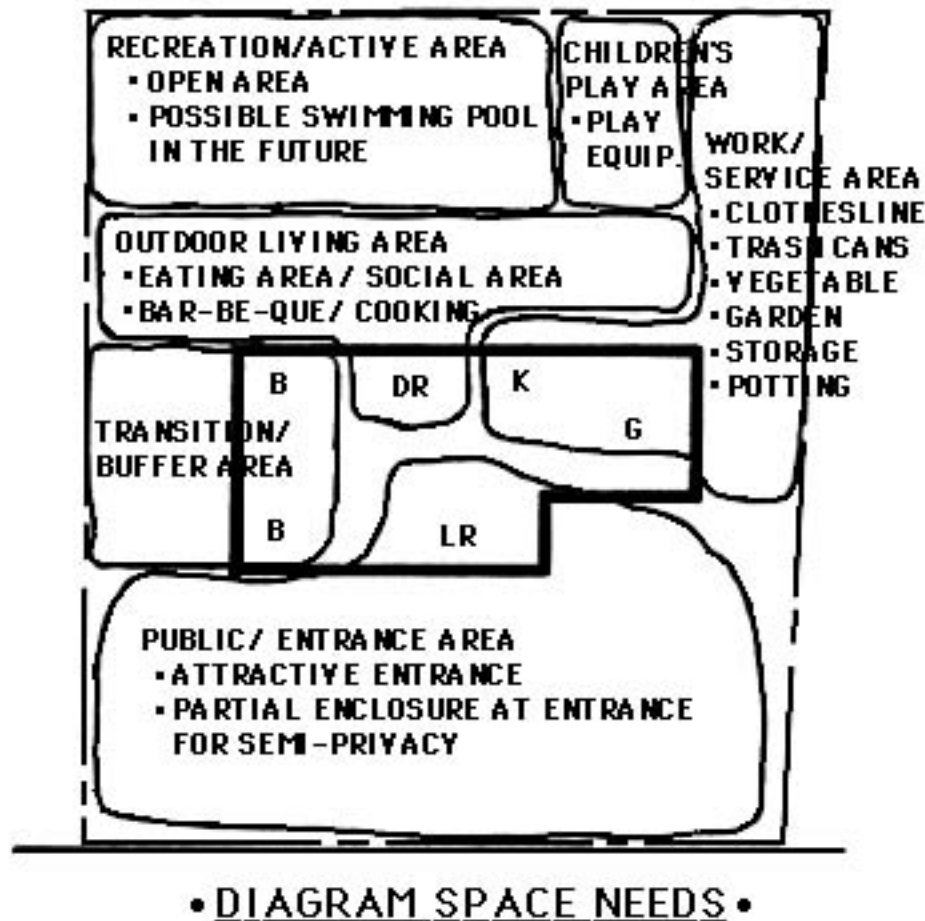

The following areas are frequently found in the home landscape. Develop each according to your family's needs and priorities.



Work or Service Area. The work or service area can be convenient, orderly and attractive. Lawnmowers, wheelbarrows, tools, insecticides and fertilizers all need to be stored in a dry convenient location. If tool and equipment space is not already provided, plan for one. Since many service areas are most convenient when adjacent to the garage or carport, consider adding your storage area to an existing wall.

Garbage storage and clotheslines should be near the kitchen and laundry rooms. Allow at least four feet around the clotheslines to keep clothes from rubbing against fences, plants and walls. If only used occasionally, retractable or folding clotheslines may be the most practical.

Service areas can also contain a compost pile or space for cutting flowers and vegetables.

Consider screening the service area from view with either structures or plants to make it an attractive as well as functional part of the landscape.

Recreation or Active Sports

Area. Features such as a swimming pool, shuffle board and tennis courts require considerable space and investment. A tennis court is normally 120 x 60 feet and a badminton court is 22 x 44 feet; swimming pools vary in size.

If some of these facilities are on your list of needs but not practical for immediate installation, you may consider leaving open turf areas that can be used for badminton, other games and play.





Outdoor Living and Entertaining Areas. Terraces and patios are an integral part of many Texas homes and should be located, if possible, where they will receive summer breezes and afternoon shade. If sun is a problem, add trees or overhead shading structures.

Outdoor living areas are usually adjacent to living areas of the house where they can easily be served and seen from inside. With the cost of interior floor space at an all-time high, outdoor living areas can economically add entertaining and living space. Even when not in use, well-planned, attractive decks and terraces adjacent to the house give a feeling of added space to interior rooms. Attractive, long-lasting outdoor furniture and accessories (such as water features, sculpture and container plants) can be useful and enrich outdoor living areas.

Some families have several outdoor living areas. Small terraces adjacent to bedrooms, bath areas and dining rooms are becoming more popular. A terrace may be placed away from the home to take advantage of a striking view, good breezes or the shade of an unusually beautiful tree.

Public and Entrance Areas. A large front yard is often a questionable use of land and resources. The parklike expanses found in some of our older subdivisions are pleasant but of little practical value. If your lot is small and building codes allow, consider developing the entrance area as a courtyard providing more use area for the family. If street parking is a problem use part of this area for off-street parking.



Parking and enclosed front courts can be both attractive and functional.

Provide shade where it will most benefit your home's energy conservation. Keep plantings simple with shrub masses, groundcovers and flowering trees used to serve real purposes.

Build walks and drives well and have them as direct and convenient as possible. Walks should be a minimum of 3 1/2 feet and preferably 4 feet wide. Provide a larger paved area at the entrance, if possible, since people tend to congregate there.

A few container plants, small flowering trees or specimen shrubs help to make the home's entrance a focal point. Other features which focalize the entrance include architectural accessories such as attractive light fixtures, street numbers and front doors.

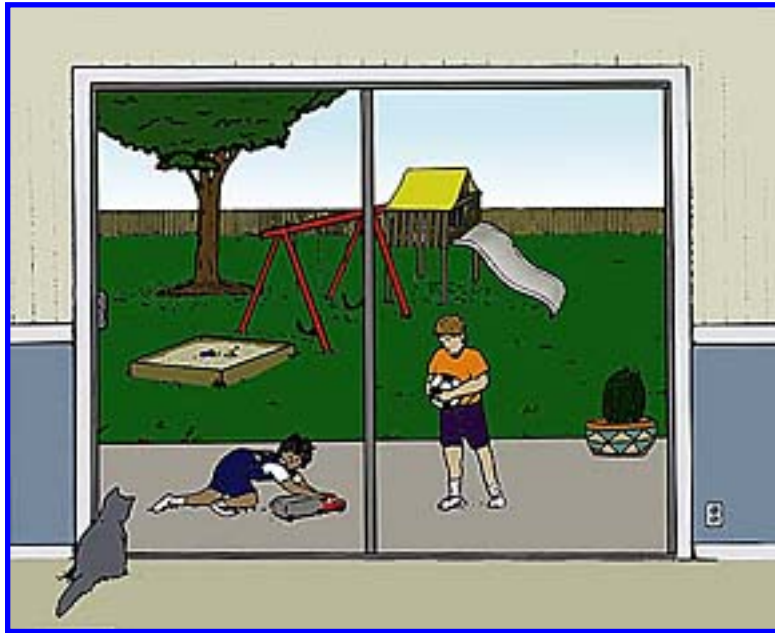

Children's Play Area. Locate the play area where someone inside the house can easily see it. A sand pile and swing sets are popular as well as paved areas for riding toys, play houses and tree houses. Keep the designs simple and easy to maintain and consider how the area might be used after the children are grown.

[Home](#) | [Base Plan](#) | [Needs](#) | [Site](#) | [Materials](#) | [Plants](#) | [Landscape Construction](#) | [Accessories](#) |



Landscaping

with [David Beaulieu](#)

Your Guide to one of [hundreds of sites](#)

[Home](#) · [Articles](#) · [Forums](#) · [Chat](#) · [Newsletters](#) · [Help](#)

Subjects

ESSENTIALS

- [Landscaping Glossary](#)
- [Landscape Solutions](#)
- [Landscaping 101](#)
- [Landscape Design for Beginners](#)
- [Landscaping FAQs](#)

BUYER'S GUIDE

- [Landscape Design](#)
- [Ornamental Trees](#)
- [Fall Foliage Trees](#)
- [Shrub Fall Colors](#)
- [Cheap Landscaping](#)
- [Easy Landscaping](#)
- [Landscape Plans](#)
- [Rock Gardens](#)
- [Patios, Walls](#)
- [Design for Birds](#)
- [Garden Pests](#)
- [Weed Control](#)
- [Bonsai, Japanese](#)
- [Shrubs, Bushes](#)
- [Decks and Arbors](#)
- [Links](#)

Landscape Design Plans

Guide picks

[Previous](#) [1](#) [2](#)

[Making Landscape Design Sketches](#)

University of Missouri Extension's advice on planning a landscape. This site offers graphics showing samples of landscape plan sketches, as well as tips based on fundamental landscaping design concepts such as proper use of texture and scale.

[Plans: Site, Specialty and Theme](#)

This resource from Homestore.com is a must-see! Site Plans, Specialty Plans and Theme Plans are each subdivided into specific categories, each with thumbnail plans pictured. Click on the thumbnail, and you go to a page with a larger image and detailed plans. Best viewed in Internet Explorer, not Netscape.

[Plans Geared to Energy Conservation](#)

Texas A&M U. Extension provides plans (graphics included) with energy efficiency in mind. Learn how to arrange trees on the landscape so as to cool the house in summer and warm it in winter.

[Visaul Help in Drawing Plans for Planting Around Your House](#)

Tips on choosing plants with which to surround your home. The images on this site allow you to visualize

[Hedges, Fences](#)
[Compost and Mulch](#)
[Fruit Trees](#)
[Ground Cover Vines](#)
[Garden Accents](#)
[Houseplants](#)
[Pond, Water Garden](#)
[Software, Hire Pro](#)
[Soil, Fertilizer](#)
[Rose Bushes](#)
[Lawn Care](#)
[Year-round Color](#)
[Gift Ideas](#)
[Top Picks](#)

[Subject Library](#)

[All articles on this topic](#)

Stay up-to-date!
Subscribe to our newsletter.

ResultsAbout

New from About.com!

[Get Paid to Improve Search](#)

Find Results Now:

[Feng Shui](#)

[Rolling Stones](#)

[Atkins Diet](#)

[Elvis Presley](#)

[Log Homes](#)

how certain plants would complement a house, depending upon the type of house, making it easier to draw plans. Includes shade plants and trees/shrubs. Proper landscaping greatly enhances the real estate value of your property.

[Previous](#) [1](#) [2](#)

[Email this page!](#)

Sponsored Links

[Distinctive Wild Bird and Garden Wildlife Products](#)

GardenBirds.com specializes in distinctive bird houses, bird feeders, bird baths and other products for garden wildlife. We have a free shipping offer and your satisfaction is guaranteed.

<http://www.GardenBirds.com/> [Sponsored Link](#)

[InsideSun Discount Garden Supplies](#)

InsideSun is your one-stop-shop for growing needs. Complete 400w HPS system only \$90. Huge discounts on MH too. Light systems and bulbs, hydroponics, nutrients, CO2, carbon scrubbers and more!

<http://www.insidesun.com/> [Sponsored Link](#)

[Home Harvest Garden Supply](#)

Fertilizers, compost, soil, discount seeds, greenhouses, nursery supplies, pest controls, pots, propagation, hydroponics, season extenders, grow lights and lots more at Home Harvest Garden Supply!

<http://homeharvest.com/> [Sponsored Link](#)

[Keep Your Home Safe - ADT](#)

Help protect your family and your home. Free security systems and free security reviews. Install a home security system from your local ADT Authorized Dealer. Find out more.

<http://www.KeepYourHomeSafe.com> [Sponsored Link](#)

[Home and Garden shopping at FurnitureFind.com!](#)

Browse a large selection of home and garden furnishings. Find quality, name brand furniture, save 30-50% and get free delivery! Call us today to take advantage of our free personal shopper service.

<http://www.furniturefind.com/> [Sponsored Link](#)

Advertising

> [Free Credit Report](#)

[Buy a Link Now!](#)

Explore More on the About Network!

| | | | | |
|--|--|--|--|---------------------|
| Related Sites Architecture Birding/Wild Birds Gardening Home Repair | Large Rats Exotic Pets Guide Lianne McLeod introduces you to the 30- inch long Gambian Giant Rat. | Decision 2004 With Wesley Clark officially in the race, U.S. Politics Guide Anne Linskey looks at all the candidates. | Malcolm X African- American History Guide Jessica McElrath tells us about the life of Malcolm X. | Search About |
|--|--|--|--|---------------------|

[About Us](#) | [Advertise on This Site](#) | [User Agreement](#) | [Privacy Policy](#) | [Kids' Privacy Policy](#) | [Help](#)

Copyright © 2003 About, Inc. About and About.com are registered trademarks of About, Inc. The About logo is a trademark of About, Inc. All rights reserved.



- [Back to the Topic Site](#)
- [Turn off this top frame](#)

- [Back to the Topic Site](#)
- [Turn off this top frame](#)

RED BRICK • YELLOW BRICK • WHITE VINYL • GREY VINYL

LANDSCAPE DESIGNS ~ RED BRICK HOUSE



Click on individual flowers in landscape drawing for planting and care information.
For printing go to [black & white version](#) of landscape.

Flowers Included ~

- [White Geraniums](#)
- [Lavender Ivy Geraniums](#)
- [White Impatiens](#)
- [Purple Petunias](#)
- [Draceana Spike](#)
- [Sprengerii](#)
- [Vinca Vine](#)
- [Dusty Miller](#)
- [Lavender Alyssum](#)

Shade Options ~

- [Fuschia](#)
- [Begonia](#)
- [Impatiens](#)
- [Forget Me Nots](#)
- [Hostas](#)
- [Coleus](#)

Trees & Shrubs Included ~

- [Blue Globe Spruce](#)
- [Anthony Waterer Spirea](#)
- [Blue Star Juniper](#)
- [Purple Lilac](#)
- [Purple Clematis](#)
- [Cedar](#)

More info ~
[Trees & Shrubs](#)

Know Your Soil ~

When it comes to planting, good soil is the foundation on which you build a good garden. And building good soil involves analyzing what you've got and supplementing what it needs.... Along with organic matter or humus there are three primary minerals that make up soil: sand, clay, and silt. The right balance of both humus and minerals will achieve garden loam, the best soil for growing plants.

For complete info visit our [Soil Smarts](#).

Planting and Spacing ~

Click on the flower in landscape or click on the flower name in the list above and you will find all the planting and care instructions for each individual flower. Or visit our extensive [Annuals](#) and [Perennials](#) section.

Spacing is a personal preference. Planting flowers closer together will give a fuller coverage in your garden and vice versa. As a general guideline you can start with the following:

1. Multiply the length by the width of your garden or planting area to get your square footage.
2. Multiply the square footage by 4. This is the number of plants you will need for full coverage in your garden.

Example:

4 foot length x 3 foot width = 12 square feet

12 square feet x 4 = 48 plants

Tips for Planning Your Garden ~

For beginners it is important to draw a plan.

- Choose plants suitable for the site (light, soil, etc).
- Arrange plants according to their height (ie taller flowers at back, shorter at front).
- Arrange according to plant form and texture.
- Arrange according to flowering periods for constant blooms.
- Arrange in groupings by type and color considerations.

GARDENER'S RESOURCE CENTER ▶▶▶

[Home](#) | [About Fernlea](#) | [Where to Buy](#) | [Your Feedback](#) | [Site Search](#) | [Site Map](#)

Email: webmaster@fernlea.com



LAMPS PLUS.
America's Lighting Superstore®
[click here!](#)

Homes by REALTOR.com®

New Homes

Apartments & Rentals

Senior Housing

Home Finance

Moving

Home & Garden

Find Local Home Services

Indoors

[Home Improvement](#)

[Decorate](#)

Outdoors

▼ [Gardening](#)

[Basics](#)

[Crafts](#)

[Features](#)

[Flowers](#)

▼ [Landscaping](#)

► [Garden Plans](#)

[Zones](#)

[Lawns](#)

[Plants](#)

[Tools](#)

[Trees & Shrubs](#)

[Pools & Spas](#)

[Decks & Patios](#)

[Garage & Driveway](#)

SITE PLANS

SPECIALTY PLANS

THEME PLANS

From *Sunset* Magazine

[Rose Gardens](#) | [Water Gardens](#) | [Cut-Flower Gardens](#) | [Fragrance Gardens](#)
[Kitchen Gardens](#) | [Bird and Butterfly Gardens](#)

Rose Gardens:



[A Rosy Corner](#)



[Roses in the Grand Manner](#)



[Roses from the Past](#)

Water Gardens:



[A Shaded Pool](#)



[Gone Fishin'](#)

Cut Flower Gardens:

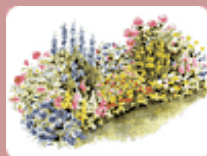

[Summer Annuals for Cutting](#)



[A Permanent Cutting Garden](#)



Try
2 1/2-lbs
of
extra-
ordinary
Gevalia
Kaffe
and
receive
a
**FREE
GIFT!**

Access Controls

[Garage door openers and parts](#)
[Gate operators](#)
[Telephone entry systems](#)
[Card entry systems](#)
[Gate & garage door opener hardware](#)

Fragrance Gardens:



[Breathe Deeply](#)

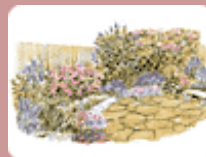

[A Scented Retreat](#)



[Pocket-Size Herb Sampler](#)



[Linger Awhile with Herbs](#)



[Formality with Flowers and Herbs](#)



[Tied Up in Knots](#)

Kitchen Gardens:



[Mixed Kitchen Garden](#)



[Kitchen Garden of Herbs](#)

Bird and Butterfly Gardens:



[Calling All Birds](#)



[Western Birdscape](#)



[Hummingbird Corner](#)



[Western Butterfly Oasis](#)



[Butterfly Island](#)

Copyright © 2000 Sunset Publishing Corporation. All rights reserved.

[Click here to reveal your gift.](#)

[Click Here To Order](#)

[Site Map](#) | [Corporate News & Info](#) | [Contact Us](#) | [Advertise With Us](#) | [Join Our Staff](#)

[Terms of Use](#) and [Privacy Policy](#).

© Copyright [Homestore, Inc.](#), 1999-2003. All rights reserved.  [Equal Housing Opportunity](#).



Landscaping

with [David Beaulieu](#)

Your Guide to one of [hundreds of sites](#)

[Home](#) · [Articles](#) · [Forums](#) · [Chat](#) · [Newsletters](#) · [Help](#)

Subjects

ESSENTIALS

- [Landscaping Glossary](#)
- [Landscape Solutions](#)
- [Landscaping 101](#)
- [Landscape Design for Beginners](#)
- [Landscaping FAQs](#)

BUYER'S GUIDE

[Landscape Design](#)

[Ornamental Trees](#)

[Fall Foliage Trees](#)

[Shrub Fall Colors](#)

[Cheap Landscaping](#)

[Easy Landscaping](#)

[Landscape Plans](#)

[Rock Gardens](#)

[Patios, Walls](#)

[Design for Birds](#)

[Garden Pests](#)

[Weed Control](#)

[Bonsai, Japanese](#)

[Shrubs, Bushes](#)

[Decks and Arbors](#)

[Links](#)

Building, Design of Wood Decks, Arbors

Guide picks

Building decks provides outdoor living spaces. Problem is, you don't know where to begin, you say? Your do-it-yourself carpentry skills are basic at best, and the prospect of deck design and construction from scratch is rather daunting? These resources will help. To further enhance your outdoor living spaces, find out how to build wooden garden arbors -- perhaps right over your decks!

The Essential Steps in Building Backyard Decks

Decks extend your living space out into the backyard. This article is geared for do-it-yourself deck design and construction. Call it Deck Building 101. You'll be made aware of the challenges that await you in your initial foray into deck construction. Common-sense problem-solving is emphasized.

Building Arbors: To Trellis Plants, Shade Decks

How to build an arbor. Arbors complement decks nicely, providing shade. Step-by-step instructions for landscaping beginners seeking to build a wooden garden arbor, supplemented by photos. The free arbor plan is designed for do-it-yourselfer: it's easy to follow and implement. Tips accompany this free landscape design plan showing how to keep the project as simple as possible.

[Hedges, Fences](#)

[Compost and Mulch](#)

[Fruit Trees](#)

[Ground Cover Vines](#)

[Garden Accents](#)

[Houseplants](#)

[Pond, Water Garden](#)

[Software, Hire Pro](#)

[Soil, Fertilizer](#)

[Rose Bushes](#)

[Lawn Care](#)

[Year-round Color](#)

[Gift Ideas](#)

[Top Picks](#)

[Subject Library](#)

[All articles on this topic](#)

Stay up-to-date!

Subscribe to our newsletter.

ResultsAbout

New from About.com!

Get Paid to Improve Search

Find Results Now:

[Feng Shui](#)

[Rolling Stones](#)

[Atkins Diet](#)

[Elvis Presley](#)

[Log Homes](#)

Pictures and Plans for Deck Design, Garden Arbor Design

Guides to the design and construction of decks and arbors, from Better Homes and Gardens. Pictures help illustrate how to build wood decks, garden arbors and other projects. Resources for building decks include a tutorial on drawing your own free deck design plans.

Email this page!

Sponsored Links

Distinctive Wild Bird and Garden Wildlife Products

GardenBirds.com specializes in distinctive bird houses, bird feeders, bird baths and other products for garden wildlife. We have a free shipping offer and your satisfaction is guaranteed.

<http://www.GardenBirds.com/> [Sponsored Link](#)

InsideSun Discount Garden Supplies

InsideSun is your one-stop-shop for growing needs. Complete 400w HPS system only \$90. Huge discounts on MH too. Light systems and bulbs, hydroponics, nutrients, CO2, carbon scrubbers and more!

<http://www.insidesun.com/> [Sponsored Link](#)

Home Harvest Garden Supply

Fertilizers, compost, soil, discount seeds, greenhouses, nursery supplies, pest controls, pots, propagation, hydroponics, season extenders, grow lights and lots more at Home Harvest Garden Supply!

<http://homeharvest.com/> [Sponsored Link](#)

Keep Your Home Safe - ADT

Help protect your family and your home. Free security systems and free security reviews. Install a home security system from your local ADT Authorized Dealer. Find out more.

<http://www.keepyourhomesafe.com> [Sponsored Link](#)

Home and Garden shopping at FurnitureFind.com!

Browse a large selection of home and garden furnishings. Find quality, name brand furniture, save 30-50% and get free delivery! Call us today to take advantage of our free personal shopper service.

Advertising

<http://www.furniturefind.com/> [Sponsored Link](#)

> [Free Credit Report](#)

[Buy a Link Now!](#)

Explore More on the About Network!

| | | | | |
|---|--|--|---|----------------------------|
| <p>Related Sites</p> <p>Architecture Birding/Wild Birds Gardening Home Repair</p> | <p><u>Large Rats</u></p> <p>Exotic Pets Guide Lianne McLeod introduces you to the 30-inch long Gambian Giant Rat.</p> | <p><u>Decision</u></p> <p><u>2004</u></p> <p>With Wesley Clark officially in the race, U.S. Politics Guide Anne Linskey looks at all the candidates.</p> | <p><u>Malcolm X</u></p> <p>African-American History Guide Jessica McElrath tells us about the life of Malcolm X.</p> | <p>Search About</p> |
|---|--|--|---|----------------------------|

[About Us](#) | [Advertise on This Site](#) | [User Agreement](#) | [Privacy Policy](#) | [Kids' Privacy Policy](#) | [Help](#)

Copyright © 2003 About, Inc. About and About.com are registered trademarks of About, Inc. The About logo is a trademark of About, Inc. All rights reserved.



Landscaping

with [David Beaulieu](#)

Your Guide to one of [hundreds of sites](#)

[Home](#) · [Articles](#) · [Forums](#) · [Chat](#) · [Newsletters](#) · [Help](#)

Subjects

ESSENTIALS

- [Landscaping Glossary](#)
- [Landscape Solutions](#)
- [Landscaping 101](#)
- [Landscape Design for Beginners](#)
- [Landscaping FAQs](#)

BUYER'S GUIDE

- [Landscape Design](#)
- [Ornamental Trees](#)
- [Fall Foliage Trees](#)
- [Shrub Fall Colors](#)
- [Cheap Landscaping](#)
- [Easy Landscaping](#)
- [Landscape Plans](#)
- [Rock Gardens](#)
- [Patio, Walls](#)
- [Design for Birds](#)
- [Garden Pests](#)
- [Weed Control](#)
- [Bonsai, Japanese](#)
- [Shrubs, Bushes](#)
- [Decks and Arbors](#)
- [Links](#)
- [Hedges, Fences](#)
- [Compost and Mulch](#)
- [Fruit Trees](#)
- [Ground Cover Vines](#)
- [Garden Accents](#)
- [Houseplants](#)

The Essential Steps in Deck Design and Construction

An Introduction to Do-It-Yourself Deck Building

 [Email to a friend](#)

 [Printer friendly version](#)

All Articles on Landscaping

- [Previous Articles](#)

From About Architecture

- [Selecting Lumber for the Deck](#)

Related Resources

- [How to Build a Brick Patio](#)

About Landscaping

Subscribe to the Free Newsletter
Your Email

Address:

So you want to build a deck? You've seen hundreds of decks on other people's landscapes, and you like the idea that building a deck will mean having an attractive "outdoor living space" at your disposal. Problem is, you don't know where to begin, you say? Your do-it-yourself carpentry skills are basic at best, and the prospect of deck design and construction from scratch is rather daunting?

Well, you've come to the right place.

This article is meant to serve as a springboard for those interested in building decks, who seek information geared for the beginner. It is beyond the scope of this article to provide an exhaustive treatise on all aspects of constructing decks. But the article should provide novices with enough information to get them started. I'll focus on the essential steps in deck building, with emphasis on the initial steps that get the project off on a sound footing. Space does not permit treatment of the finishing touches, such as railings and deck sealers. My goal is simply to furnish you with a solid foundation – both literally and figuratively.

Once beginners get started on a project as complex as this one, one of their most obvious needs will be to ask questions. An opportunity to do so will arise when they shop for lumber and other supplies for the deck project at a hardware store. The hardware store can be a great source of free information. But to ask intelligent questions, you need some knowledge of the subject

[Pond, Water Garden](#)
[Software, Hire Pro](#)
[Soil, Fertilizer](#)
[Rose Bushes](#)
[Lawn Care](#)
[Year-round Color](#)
[Gift Ideas](#)
[Top Picks](#)

[Subject Library](#)

[All articles on this topic](#)

Stay up-to-date!
Subscribe to our newsletter.

ResultsAbout

New from About.com!

[Get Paid to Improve Search](#)

Find Results Now:

[Feng Shui](#)
[Rolling Stones](#)
[Atkins Diet](#)
[Elvis Presley](#)
[Log Homes](#)

Advertising

> [Free Credit Report](#)

already, including knowledge of the terminology used to discuss the various aspects of it. You also need an introduction to some basic problem solving in deck construction. For instance, on Page 3 we discuss the freestanding deck as an alternative to the type that gets secured directly to a house. Why? Because although you can still place a freestanding deck adjacent to a house, a freestanding deck obviates a problem for the non-carpenter: namely, it avoids having to remove siding from your house (a scary thought for most of us).

You need to be made aware of such challenges that await you in your initial foray into deck construction. Once you become aware of the problems – and mull over some suggestions as to how to solve them – you’ll be brimming with astute questions when you walk into the hardware store. Speaking of the hardware store, some of the supplies you’ll need to build a deck are likely to include the following:

- Flashing
- Caulking compound
- Pre-mixed concrete
- Gravel or crushed stone
- Cinder blocks
- Post caps
- Post bases
- Seismic ties
- Joist hangers
- Cardboard tube concrete forms
- Rebar
- Stainless steel or HDG nails (either ring-shank nails or spiral-groove, for better holding power; alternatively, use screws)
- Joist hanger nails
- HDG bolts or lag screws, and washers

The following are some of the tools you may need for this deck project:

- Shovel
- Carpenter’s level
- Carpenter’s square
- Plumb bob
- Wheelbarrow (for mixing concrete)
- Caulking gun
- Drill
- Wrench (to tighten lag screws)
- Hammer
- Circular saw

- Tape measure
- Safety eyewear
- Scrap lumber for bracing

On Page 2 we'll have a look at another supply you'll need for this deck project – the wood....

1 | [2](#) | [3](#) | [4](#) | [5](#) | [next](#)

[Email this page!](#)

Sponsored Links

[Distinctive Wild Bird and Garden Wildlife Products](#)

GardenBirds.com specializes in distinctive bird houses, bird feeders, bird baths and other products for garden wildlife. We have a free shipping offer and your satisfaction is guaranteed.

<http://www.GardenBirds.com/> [Sponsored Link](#)

[InsideSun Discount Garden Supplies](#)

InsideSun is your one-stop-shop for growing needs. Complete 400w HPS system only \$90. Huge discounts on MH too. Light systems and bulbs, hydroponics, nutrients, CO2, carbon scrubbers and more!

<http://www.insidesun.com/> [Sponsored Link](#)

[Home Harvest Garden Supply](#)

Fertilizers, compost, soil, discount seeds, greenhouses, nursery supplies, pest controls, pots, propagation, hydroponics, season extenders, grow lights and lots more at Home Harvest Garden Supply!

<http://homeharvest.com/> [Sponsored Link](#)

[Keep Your Home Safe - ADT](#)

Help protect your family and your home. Free security systems and free security reviews. Install a home security system from your local ADT Authorized Dealer. Find out more.

<http://www.keepyourhomesafe.com> [Sponsored Link](#)

[Home and Garden shopping at FurnitureFind.com!](#)

Browse a large selection of home and garden furnishings. Find quality, name brand furniture, save 30-50% and get free delivery! Call us today to take advantage of our free personal shopper service.

<http://www.furniturefind.com/> [Sponsored Link](#)

[Buy a Link Now!](#)

Explore More on the About Network!

| | | | | |
|--|---|--|--|---------------------|
| Related Sites Architecture Birding/Wild Birds Gardening Home Repair | <u>Large Rats</u> Exotic Pets Guide Lianne McLeod introduces you to the 30-inch long Gambian Giant Rat. | <u>Decision 2004</u> With Wesley Clark officially in the race, U.S. Politics Guide Anne Linskey looks at all the candidates. | <u>Malcolm X</u> African-American History Guide Jessica McElrath tells us about the life of Malcolm X. | Search About |
|--|---|--|--|---------------------|

[About Us](#) | [Advertise on This Site](#) | [User Agreement](#) | [Privacy Policy](#) | [Kids' Privacy Policy](#) | [Help](#)

Copyright © 2003 About, Inc. About and About.com are registered trademarks of About, Inc. The About logo is a trademark of About, Inc. All rights reserved.



- Back to the Topic Site
- Turn off this top frame



Our Site Tools

Weather

- San Francisco ↑80 ↓55
- San Jose ↑86 ↓55
- Oakland ↑77 ↓55

Local Events

Yellow Pages

Discussion Boards

Maps & Directions

Attention BayArea.com readers,

After several years of co-existing under the umbrella BayArea.com, the Mercury News and Contra Costa Times have split into separate sites, MercuryNews.com and ContraCostaTimes.com.

Click below if you are looking for:

- » [The Mercury News](#)
- » [Contra Costa Times](#)
- » [SiliconValley.com](#)
- » [Viet Mercury](#)
- » [Nuevo Mundo](#)
- » [Newspaper Archives](#)
- » [Classifieds](#)

Shopping & Services

Find a [Job](#), a [Car](#), an [Apartment](#), a [Home](#), and more...

Each site contains the complete content of the newspaper, news archives, up-to-the-moment breaking news plus expanded classified listings and display ads online.

Each change and enhancement is driven by user feedback, so please [let us know](#) how our execution matches up to your expectations.

To help you find what you are looking for, we have created the following list of new links to popular destinations on the Web sites. Please update your bookmarks accordingly.

Click below for:

MercuryNews.com

- [Entertainment](#)
- [Lifestyles](#)
- [Classifieds](#)
- [Obituaries](#)
- [Sports](#)
- [News](#)
- [Business](#)

ContraCostaTimes.com

- [Timeout Entertainment](#)
- [Timeout Features Section](#)
- [Classifieds](#)
- [Obituaries](#)
- [Sports](#)
- [News](#)
- [Business](#)

Use the site indices to the MercuryNews.com and ContraCostaTimes.com to find other parts of our sites.

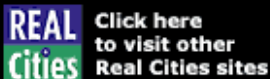



Landscaping

with [David Beaulieu](#)

Your Guide to one of [hundreds of sites](#)

[Home](#) · [Articles](#) · [Forums](#) · [Chat](#) · [Newsletters](#) · [Help](#)

Subjects

How to Build Outdoor Wooden Decks

page 2

ESSENTIALS

- [Landscaping Glossary](#)
- [Landscape Solutions](#)
- [Landscaping 101](#)
- [Landscape Design for Beginners](#)
- [Landscaping FAQs](#)

BUYER'S GUIDE

- [Landscape Design](#)
- [Ornamental Trees](#)
- [Fall Foliage Trees](#)
- [Shrub Fall Colors](#)
- [Cheap Landscaping](#)
- [Easy Landscaping](#)
- [Landscape Plans](#)
- [Rock Gardens](#)
- [Patio, Walls](#)
- [Design for Birds](#)
- [Garden Pests](#)
- [Weed Control](#)
- [Bonsai, Japanese](#)
- [Shrubs, Bushes](#)
- [Decks and Arbors](#)
- [Links](#)
- [Hedges, Fences](#)
- [Compost and Mulch](#)
- [Fruit Trees](#)
- [Ground Cover Vines](#)
- [Garden Accents](#)
- [Houseplants](#)

How Zoning Laws, Building Codes Affect Deck Design

 [Email to a friend](#)

 [Printer friendly version](#)

All Articles on Landscaping

- [Previous Articles](#)

From About Architecture

- [Selecting Lumber for the Deck](#)

Related Resources

- [How to Build a Brick Patio](#)

About Landscaping

Subscribe to the Free Newsletter
Your Email

Address:

To build an outdoor wooden deck, obviously the primary supply needed will be the wood. It would be nice if I could provide the dimensions for your lumber, but there are really too many variables involved to give precise dimensions. Lumber dimensions would depend, for example, on the type of wood that you choose: pressure-treated, cedar, etc. The size of the deck is another variable.

Perhaps even more frustrating is the fact that, when all is said and done, the choice about lumber dimensions is probably not yours to make, anyhow. Zoning laws and building codes will have a lot to say about what you can and cannot do in your deck project.

Before you even begin with your deck design (let alone deck construction), check into local zoning ordinances. Depending on where you live, you may be surprised to learn just how restrictive zoning can be.

You should talk with your local building inspector, too, so as to comply with building codes in your area. Usually you'll need to file for a building permit. Don't look at your chat with the building inspector as all bad, though. For here's another chance to pose some intelligent questions about deck building and get some free answers from someone with a wealth of information on the subject.

Local building codes may tell you specifically what lumber

[Pond, Water Garden](#)
[Software, Hire Pro](#)
[Soil, Fertilizer](#)
[Rose Bushes](#)
[Lawn Care](#)
[Year-round Color](#)
[Gift Ideas](#)
[Top Picks](#)

[Subject Library](#)

[All articles on this topic](#)

Stay up-to-date!
Subscribe to our newsletter.

ResultsAbout

New from About.com!

[Get Paid to Improve Search](#)

Find Results Now:

[Feng Shui](#)
[Rolling Stones](#)
[Atkins Diet](#)
[Elvis Presley](#)
[Log Homes](#)

Advertising

> [Free Credit Report](#)

dimensions you need. Because they are *local*, there's no point in speculating about them here. But, for the purposes of this article, I will assume that the posts you'll be using as underpinnings for the deck are either 4x4s or 6x6s. I'll assume the rest of the lumber will be 2 x something (at least 2x6, and possibly as high as 2x12). Note, however, that a 2x10, for instance, is not really 2" by 10" (that's just a naming convention). It's really 1.5" x 9.5".

Getting Started With the Deck Construction: Preparing the Site

Upon finishing your deck design plans and assembling the necessary tools and supplies, step one of construction will begin: preparing the site. This step is necessary if you'll be building the deck over an area that is currently grass-covered.

Once you know how large a rectangle you want the finished deck to occupy, measure out this area and make marks on the ground to indicate where the deck will lie. To ensure that your rectangle is true, measure diagonally from corner to corner, both ways (i.e., upper left to lower right, and upper right to lower left). You want these measurements to be equal.

Using a shovel, remove any grass or weeds from this measured area, to form your working space. Later, before closing off this working space with decking, apply mulch over this space to suppress weeds. But for now, your main concern is to furnish yourself with as level a working space as possible. This will be important later in the project, when you dig holes for concrete piers – which need to end up at the same height! You'll be more likely to achieve this if you start off on level ground.

On Page 3 we'll take a look at what may be one of the major decisions you'll need to make in your deck-building project....

[previous](#) | [1](#) | [2](#) | [3](#) | [4](#) | [5](#) | [next](#)

[Email this page!](#)

Sponsored Links

[Distinctive Wild Bird and Garden Wildlife Products](#)

GardenBirds.com specializes in distinctive bird houses, bird feeders, bird baths and other products for garden wildlife. We have a free shipping offer and your satisfaction is guaranteed.

<http://www.GardenBirds.com/> [Sponsored Link](#)

InsideSun Discount Garden Supplies

InsideSun is your one-stop-shop for growing needs. Complete 400w HPS system only \$90. Huge discounts on MH too. Light systems and bulbs, hydroponics, nutrients, CO2, carbon scrubbers and more!

<http://www.insidesun.com/> [Sponsored Link](#)

Home Harvest Garden Supply

Fertilizers, compost, soil, discount seeds, greenhouses, nursery supplies, pest controls, pots, propagation, hydroponics, season extenders, grow lights and lots more at Home Harvest Garden Supply!

<http://homeharvest.com/> [Sponsored Link](#)

Keep Your Home Safe - ADT

Help protect your family and your home. Free security systems and free security reviews. Install a home security system from your local ADT Authorized Dealer. Find out more.

<http://www.keepyourhomesafe.com> [Sponsored Link](#)

Home and Garden shopping at FurnitureFind.com!

Browse a large selection of home and garden furnishings. Find quality, name brand furniture, save 30-50% and get free delivery! Call us today to take advantage of our free personal shopper service.

<http://www.furniturefind.com/> [Sponsored Link](#)

Buy a Link Now!

Explore More on the About Network!

| | | | | |
|---|--|--|---|----------------------------|
| <p>Related Sites</p> <p>Architecture Birding/Wild Birds Gardening Home Repair</p> | <p>Large Rats</p> <p>Exotic Pets Guide Lianne McLeod introduces you to the 30-inch long Gambian Giant Rat.</p> | <p>Decision 2004</p> <p>With Wesley Clark officially in the race, U.S. Politics Guide Anne Linskey looks at all the candidates.</p> | <p>Malcolm X</p> <p>African-American History Guide Jessica McElrath tells us about the life of Malcolm X.</p> | <p>Search About</p> |
|---|--|--|---|----------------------------|

[About Us](#) | [Advertise on This Site](#) | [User Agreement](#) | [Privacy Policy](#) | [Kids' Privacy Policy](#) | [Help](#)

Copyright © 2003 About, Inc. About and About.com are registered trademarks of About, Inc. The About logo is a trademark of About, Inc. All rights reserved.



Landscaping

with [David Beaulieu](#)

Your Guide to one of [hundreds of sites](#)

[Home](#) · [Articles](#) · [Forums](#) · [Chat](#) · [Newsletters](#) · [Help](#)

Subjects

Building a Freestanding Backyard Deck

page 3

ESSENTIALS

- [Landscaping Glossary](#)
- [Landscape Solutions](#)
- [Landscaping 101](#)
- [Landscape Design for Beginners](#)
- [Landscaping FAQs](#)

BUYER'S GUIDE

- [Landscape Design](#)
- [Ornamental Trees](#)
- [Fall Foliage Trees](#)
- [Shrub Fall Colors](#)
- [Cheap Landscaping](#)
- [Easy Landscaping](#)
- [Landscape Plans](#)
- [Rock Gardens](#)
- [Patios, Walls](#)
- [Design for Birds](#)
- [Garden Pests](#)
- [Weed Control](#)
- [Bonsai, Japanese](#)
- [Shrubs, Bushes](#)
- [Decks and Arbors](#)
- [Links](#)
- [Hedges, Fences](#)
- [Compost and Mulch](#)
- [Fruit Trees](#)
- [Ground Cover Vines](#)
- [Garden Accents](#)
- [Houseplants](#)

A Do-It-Yourself Alternative to Traditional Deck Design

 [Email to a friend](#)

 [Printer friendly version](#)

All Articles on Landscaping

- [Previous Articles](#)

From About Architecture

- [Selecting Lumber for the Deck](#)

Related Resources

- [How to Build a Brick Patio](#)

About Landscaping

Subscribe to the Free Newsletter
Your Email

Address:

Although the backyard deck doesn't have to be an extension of the house, the majority of decks do abut against a house wall. Building such a deck can present a challenge. On this page I discuss an alternative that is easier - freestanding decks.

Decks that rest smack up against a house usually derive structural support on that end by being attached to the house with bolts (or lag screws). But you can't just blindly shove the bolt anywhere. Since you're trying to achieve structural support, the wood in that area needs to be part of something substantial, something that is part of the underlying framework of the house: either the wall studs or floor joists. But you and your deck need to gain access to this solid wood – meaning you have to remove the siding of your house in that area (i.e., if your house is covered with clapboard, vinyl siding, aluminum siding, or beveled wood).

For the non-carpenter, removing your house's siding is a pretty scary proposition. Let's face it: Most of us take a "Leave well enough alone!" attitude towards our houses. We don't want to screw up anything....

The good news is that there's an alternative method, while still building the deck adjacent to your house: namely, the freestanding deck. Freestanding decks are a bit more work, because the house-end of the freestanding deck will have to rest on piers, in lieu of being connected to the house. That means

[Pond, Water Garden](#)
[Software, Hire Pro](#)
[Soil, Fertilizer](#)
[Rose Bushes](#)
[Lawn Care](#)
[Year-round Color](#)
[Gift Ideas](#)
[Top Picks](#)

[Subject Library](#)

[All articles on this topic](#)

Stay up-to-date!
Subscribe to our newsletter.

Results About
New from About.com!

[Get Paid to Improve Search](#)

Find Results Now:

[Feng Shui](#)
[Rolling Stones](#)
[Atkins Diet](#)
[Elvis Presley](#)
[Log Homes](#)

Advertising
> [Free Credit Report](#)

extra digging for you, and additional concrete work. But for the sake of your peace of mind, this alternative may be worth the extra work.

But now that you know about freestanding decks, I'll discuss the other method as well -- that of attaching the deck directly to the house for support -- just in case you're feeling brave.

Carefully mark out where the [header board](#) should be attached to your house. The level at which the top of the header board rests should be the same as the level of your [joists](#), atop which you will be attaching your [decking](#). It is critical to ensure that the header is not only at the proper height, but also that it is level. The success of the whole project depends on this. The length of the header board equals the total length of the deck, minus 3". Why minus 3"? Because the outermost joist on the left of the deck, as well as that on the right (as you face the house), should overlap the header board and be nailed to it. The joists will be, let's say, 2 x 8s. As mentioned on the previous page, that means they're actually 1 1/2" thick. Then multiply by 2.

Remove the siding where the header board must go. Tuck flashing up under the piece of siding that remains above this area. Roll the flashing down the side of the house, low enough that it will extend to a level below the bottom of your header board (the flashing will rest between the wall and the header board). Form a "lip" at the bottom, so that the water will be channeled away from the house. On the flashing, make marks where the bolts or lag screws must penetrate. Pre-drill the holes and caulk them.

Make corresponding marks on the header board, and make sure everything lines up. Now drill holes in the header board for the bolts or lag screws, and caulk the holes to further seal off your work from moisture problems. A slight space must also be left between the header and the wall, to allow rain to run freely down between the wall and the back of the header, averting rot. If you slide washers onto the lag screws or bolts in the back before securing the header, you'll create the spacing you need. Tighten the bolts or lag screws.

That takes care of the house-end of the deck. On Page 4 we'll proceed to the sides, as well as to the opposite end....

[previous](#) | [1](#) | [2](#) | **[3](#)** | [4](#) | [5](#) | [next](#)

[Email this page!](#)

Sponsored Links

[Distinctive Wild Bird and Garden Wildlife Products](#)

GardenBirds.com specializes in distinctive bird houses, bird feeders, bird baths and other products for garden wildlife. We have a free shipping offer and your satisfaction is guaranteed.

<http://www.GardenBirds.com/> [Sponsored Link](#)

[InsideSun Discount Garden Supplies](#)

InsideSun is your one-stop-shop for growing needs. Complete 400w HPS system only \$90. Huge discounts on MH too. Light systems and bulbs, hydroponics, nutrients, CO2, carbon scrubbers and more!

<http://www.insidesun.com/> [Sponsored Link](#)

[Home Harvest Garden Supply](#)

Fertilizers, compost, soil, discount seeds, greenhouses, nursery supplies, pest controls, pots, propagation, hydroponics, season extenders, grow lights and lots more at Home Harvest Garden Supply!

<http://homeharvest.com/> [Sponsored Link](#)

[Keep Your Home Safe - ADT](#)

Help protect your family and your home. Free security systems and free security reviews. Install a home security system from your local ADT Authorized Dealer. Find out more.

<http://www.keepyourhomesafe.com> [Sponsored Link](#)

[Home and Garden shopping at FurnitureFind.com!](#)

Browse a large selection of home and garden furnishings. Find quality, name brand furniture, save 30-50% and get free delivery! Call us today to take advantage of our free personal shopper service.

<http://www.furniturefind.com/> [Sponsored Link](#)

[Buy a Link Now!](#)

Explore More on the About Network!

| | | | | |
|---|--|---|---|----------------------------|
| <p>Related Sites</p> <p>Architecture Birding/Wild Birds Gardening Home Repair</p> | <p><u>Large Rats</u></p> <p>Exotic Pets Guide Lianne McLeod introduces you to the 30-inch long Gambian Giant Rat.</p> | <p><u>Decision 2004</u></p> <p>With Wesley Clark officially in the race, U.S. Politics Guide Anne Linskey looks at all the candidates.</p> | <p><u>Malcolm X</u></p> <p>African-American History Guide Jessica McElrath tells us about the life of Malcolm X.</p> | <p>Search About</p> |
|---|--|---|---|----------------------------|

[About Us](#) | [Advertise on This Site](#) | [User Agreement](#) | [Privacy Policy](#) | [Kids' Privacy Policy](#) | [Help](#)

Copyright © 2003 About, Inc. About and About.com are registered trademarks of About, Inc. The About logo is a trademark of About, Inc. All rights reserved.



Landscaping

with [David Beaulieu](#)

Your Guide to one of [hundreds of sites](#)

[Home](#) · [Articles](#) · [Forums](#) · [Chat](#) · [Newsletters](#) · [Help](#)

Subjects

ESSENTIALS

- [Landscaping Glossary](#)
- [Landscape Solutions](#)
- [Landscaping 101](#)
- [Landscape Design for Beginners](#)
- [Landscaping FAQs](#)

BUYER'S GUIDE

- [Landscape Design](#)
- [Ornamental Trees](#)
- [Fall Foliage Trees](#)
- [Shrub Fall Colors](#)
- [Cheap Landscaping](#)
- [Easy Landscaping](#)
- [Landscape Plans](#)
- [Rock Gardens](#)
- [Patio, Walls](#)
- [Design for Birds](#)
- [Garden Pests](#)
- [Weed Control](#)
- [Bonsai, Japanese](#)
- [Shrubs, Bushes](#)
- [Decks and Arbors](#)
- [Links](#)
- [Hedges, Fences](#)
- [Compost and Mulch](#)
- [Fruit Trees](#)
- [Ground Cover Vines](#)
- [Garden Accents](#)
- [Houseplants](#)

Do-It-Yourself Deck Construction: Foundations for Decks

page 4

Footings, Piers and Posts for Your Wood Deck

With the header board in place, support has now been provided for the deck at the house-end. At the opposite end, support will derive from a pier of some sort, sunk into the ground. Deck builders use a variety of techniques to accomplish this, but I will present one that I believe to be easiest for do-it-yourself deck building.

These deck piers do not have to be located at the very edge of the deck. In fact, many deck builders prefer the look of having the piers hidden from view, a few feet back from the edge. Likewise for the 2 sides. The number of piers and pier spacing is determined by local building codes.

Before digging, it will be helpful to nail the two outermost joists (extreme left and extreme right, as you face the house) to the header board. At the opposite end, use temporary braces to prop them up. These joists can serve as a reference point when working on the pier holes. More importantly, make sure that these 2 joists are level – both front to back along the same joist, as well as across the span from one joist to the other (at both ends). Don't be afraid to fuss over this now, even if it takes quite a bit of time to get it just right. You'll spare yourself a plethora of problems later. You'll be calculating the height of your ground supports based on the level of these joists.

Nor is levelness your only concern. You really want your rectangle

[Email to a friend](#)

[Printer friendly version](#)

All Articles on Landscaping

- [Previous Articles](#)

From About Architecture

- [Selecting Lumber for the Deck](#)

Related Resources

- [How to Build a Brick Patio](#)

About Landscaping

Subscribe to the Free Newsletter
Your Email

Address:

[Pond, Water Garden](#)
[Software, Hire Pro](#)
[Soil, Fertilizer](#)
[Rose Bushes](#)
[Lawn Care](#)
[Year-round Color](#)
[Gift Ideas](#)
[Top Picks](#)

[Subject Library](#)

[All articles on this topic](#)

Stay up-to-date!
Subscribe to our newsletter.

ResultsAbout
New from About.com!

[Get Paid to Improve Search](#)

Find Results Now:

[Feng Shui](#)
[Rolling Stones](#)
[Atkins Diet](#)
[Elvis Presley](#)
[Log Homes](#)

Advertising
> [Free Credit Report](#)

to start taking shape as soon as possible, so that you can begin squaring up your angles. For the joists must form right angles with the header board; use a carpenter's square to make sure you begin building your rectangular frame at perfect right angles. Remembering a little high school geometry here certainly doesn't hurt your chances. You can make use of the fact that, in a right triangle with a base of 3', the side perpendicular to the base will be 4', and the diagonal side 5'. If your angle is off, now is the time to adjust it – not after everything is secured!

After installing these outermost joists, run a tape measure down from the header along each joist, stopping at the distance where you've determined the piers should be. Mark it. Now run a string tightly between these 2 marks, from joist to joist, spanning the whole width of the deck. This string will be your guide as to where to locate the piers. Run a plumb bob down from this string to the ground, and mark that spot. You are now ready to begin digging.

Pier holes should extend below the frost line to avoid heaving during freeze and thaw cycles. Dig each hole the same depth, again using the plumb bob as a guide. At the bottom apply a layer of crushed stone. Mix concrete and build a small form for a square concrete footing, according to building codes. Let the concrete cure. You are now ready to do more concrete work, this time for the pier itself.

Hardware stores carry a waxed cardboard tube used as a circular concrete form. Just set this form on the cured footing, plumb it, and mix and pour more concrete. Etching marks on the forms to serve as guides, make each pier the same height. Reinforce the concrete with rebar. You'll want the top of your concrete piers to be about 2' above ground level. Before the concrete cures, place a post base onto the top of each pier. These post bases will allow you to unite the wooden posts you're using with the concrete piers. Allow the concrete to cure again.

One of the biggest challenges in deck building will be encountered at this point in the project: making the house-end and the opposite end of the deck the same height. More than at any other step, this is the place to apply the do-it-yourself carpenter's golden rule: Play around with it first as much as possible to get the right alignment, before cutting anything or securing anything. Otherwise, you only have one chance to get it right – in which case, I don't like my chances!

On Page 5 we'll tackle this challenge -- the last difficult step in building a deck.

[Email this page!](#)

Sponsored Links

[Distinctive Wild Bird and Garden Wildlife Products](#)

GardenBirds.com specializes in distinctive bird houses, bird feeders, bird baths and other products for garden wildlife. We have a free shipping offer and your satisfaction is guaranteed.

<http://www.GardenBirds.com/> [Sponsored Link](#)

[InsideSun Discount Garden Supplies](#)

InsideSun is your one-stop-shop for growing needs. Complete 400w HPS system only \$90. Huge discounts on MH too. Light systems and bulbs, hydroponics, nutrients, CO2, carbon scrubbers and more!

<http://www.insidesun.com/> [Sponsored Link](#)

[Home Harvest Garden Supply](#)

Fertilizers, compost, soil, discount seeds, greenhouses, nursery supplies, pest controls, pots, propagation, hydroponics, season extenders, grow lights and lots more at Home Harvest Garden Supply!

<http://homeharvest.com/> [Sponsored Link](#)

[Keep Your Home Safe - ADT](#)

Help protect your family and your home. Free security systems and free security reviews. Install a home security system from your local ADT Authorized Dealer. Find out more.

<http://www.keepyourhomesafe.com> [Sponsored Link](#)

[Home and Garden shopping at FurnitureFind.com!](#)

Browse a large selection of home and garden furnishings. Find quality, name brand furniture, save 30-50% and get free delivery! Call us today to take advantage of our free personal shopper service.

<http://www.furniturefind.com/> [Sponsored Link](#)

[Buy a Link Now!](#)

Explore More on the About Network!

| | | | | |
|---|--|---|---|----------------------------|
| <p>Related Sites</p> <p>Architecture Birding/Wild Birds Gardening Home Repair</p> | <p><u>Large Rats</u></p> <p>Exotic Pets Guide Lianne McLeod introduces you to the 30-inch long Gambian Giant Rat.</p> | <p><u>Decision 2004</u></p> <p>With Wesley Clark officially in the race, U.S. Politics Guide Anne Linskey looks at all the candidates.</p> | <p><u>Malcolm X</u></p> <p>African-American History Guide Jessica McElrath tells us about the life of Malcolm X.</p> | <p>Search About</p> |
|---|--|---|---|----------------------------|

[About Us](#) | [Advertise on This Site](#) | [User Agreement](#) | [Privacy Policy](#) | [Kids' Privacy Policy](#) | [Help](#)

Copyright © 2003 About, Inc. About and About.com are registered trademarks of About, Inc. The About logo is a trademark of About, Inc. All rights reserved.



Landscaping

with [David Beaulieu](#)

Your Guide to one of [hundreds of sites](#)

[Home](#) · [Articles](#) · [Forums](#) · [Chat](#) · [Newsletters](#) · [Help](#)

Subjects

Deck Design: Keep It on the Level

page 5

ESSENTIALS

- [Landscaping Glossary](#)
- [Landscape Solutions](#)
- [Landscaping 101](#)
- [Landscape Design for Beginners](#)
- [Landscaping FAQs](#)

BUYER'S GUIDE

- [Landscape Design](#)
- [Ornamental Trees](#)
- [Fall Foliage Trees](#)
- [Shrub Fall Colors](#)
- [Cheap Landscaping](#)
- [Easy Landscaping](#)
- [Landscape Plans](#)
- [Rock Gardens](#)
- [Patios, Walls](#)
- [Design for Birds](#)
- [Garden Pests](#)
- [Weed Control](#)
- [Bonsai, Japanese](#)
- [Shrubs, Bushes](#)
- [Decks and Arbors](#)
- [Links](#)
- [Hedges, Fences](#)
- [Compost and Mulch](#)
- [Fruit Trees](#)
- [Ground Cover Vines](#)
- [Garden Accents](#)
- [Houseplants](#)

Using Cinder Blocks as Temporary Supports

Use cinder blocks at this point to stand in temporarily for the wooden posts. That way, you can play around with the height and make sure you get it level (for the components at this end of the deck, see picture on right). But how do you check for levelness across such long distances? The answer is to run a long, straight board from the header to cinder blocks at the other end, and place your carpenter's level upon this board. Once you've found the height that will give you a level deck, you can just take note of the distance covered from the bottom of the cinder blocks to the top of the cinder blocks.

But what about levelness in the other dimension – left to right? If you've been careful so far in installing your header board and side joists (keeping everything level), you'll now reap the rewards for your attention to detail. The side joists are your guides for keeping everything level left to right.

Using the measurements obtained from playing with the cinder blocks, you can determine the length the posts need to be.

But the posts alone do *not* span the distance from the tops of the



Cross-section of deck, at the girder-end. This picture shows how the deck components "stack up."

David Beaulieu

[Email to a friend](#)

[Printer friendly version](#)

All Articles on Landscaping

- [Previous Articles](#)

From About Architecture

- [Selecting Lumber for the Deck](#)

Related Resources

- [How to Build a Brick Patio](#)

About Landscaping

Subscribe to the Free Newsletter
Your Email

Address:

[Pond, Water Garden](#)
[Software, Hire Pro](#)
[Soil, Fertilizer](#)
[Rose Bushes](#)
[Lawn Care](#)
[Year-round Color](#)
[Gift Ideas](#)
[Top Picks](#)

[Subject Library](#)

[All articles on this topic](#)

Stay up-to-date!
Subscribe to our newsletter.

ResultsAbout
New from About.com!

[Get Paid to Improve Search](#)

Find Results Now:

[Feng Shui](#)
[Rolling Stones](#)
[Atkins Diet](#)
[Elvis Presley](#)
[Log Homes](#)

Advertising
> [Free Credit Report](#)

piers to the bottom of the joists. On this end of the deck we'll be using another piece of wood that will rest upon the posts, called a "girder." The [girder](#) roughly corresponds to the header board at the other end, in the sense that it will serve as the support for the joists. But there's an important difference. Joists will "hang" from the header board using joist hangers (which keeps them on the same level as the header board), but on the opposite end, joists will rest *on top* of the girder. The girder will be the length of the header board plus 3". Deck builders often unite 2 boards to form a nice thick girder; for instance, two 2x10s to form, in essence, a 4x10.

Therefore it is the height of the joist *plus* the height of the girder *plus* the height of the post that the temporary cinder blocks spanned vertically. Or to put it another way: Take the distance covered by the cinder blocks from top to bottom, subtract the height of the joist and the height of the girder from it, and you'll have the height needed for the posts (see picture at upper right). Cut posts accordingly.

With both the posts and the girder cut to the right lengths, assemble them to form a unit, using post caps. Transfer this unit onto the concrete piers, using the post bases previously installed in the concrete to fasten the posts to the piers. Once the post-and-girder unit is secured to the piers, the top of the girder should meet the bottoms of the two outermost joists. If so, we've successfully completed the hard part of this project!

Although it's still possible to screw something up later in the project, we'd probably be able to rectify it easily enough. It is in this sense that I referred on Page 1 to the steps presented in this article as the "essential" steps. If these steps are botched, you'll probably have to start over from square one. But if you get through them successfully, the rest isn't too bad.

That's why I've focused on the project's initial steps. Once completed, you'll simply install the other joists. You'll use fasteners called "seismic ties" to attach the joists to the girders. Let the joists at this end stick out beyond the girder willy-nilly, until they're all in place. Then cut their ends off all at once, at some predetermined distance from the piers. These ends can be capped by a face board, if you prefer that look.

Your final major step is cutting the decking boards themselves and nailing or screwing them to the tops of the joists. Stagger the decking so that the seams don't all line up; the deck will not only be more stable structurally this way, but will also look better. If

your deck will be high off the ground, building codes dictate adding a railing.

But believe me: After all we've been through up to this point, the railing will be a piece of cake.

~ [David Beaulieu](#)

[previous](#) | [1](#) | [2](#) | [3](#) | [4](#) | **5**

[Email this page!](#)

Sponsored Links

[Distinctive Wild Bird and Garden Wildlife Products](#)

GardenBirds.com specializes in distinctive bird houses, bird feeders, bird baths and other products for garden wildlife. We have a free shipping offer and your satisfaction is guaranteed.

<http://www.GardenBirds.com/> [Sponsored Link](#)

[InsideSun Discount Garden Supplies](#)

InsideSun is your one-stop-shop for growing needs. Complete 400w HPS system only \$90. Huge discounts on MH too. Light systems and bulbs, hydroponics, nutrients, CO2, carbon scrubbers and more!

<http://www.insidesun.com/> [Sponsored Link](#)

[Home Harvest Garden Supply](#)

Fertilizers, compost, soil, discount seeds, greenhouses, nursery supplies, pest controls, pots, propagation, hydroponics, season extenders, grow lights and lots more at Home Harvest Garden Supply!

<http://homeharvest.com/> [Sponsored Link](#)

[Keep Your Home Safe - ADT](#)

Help protect your family and your home. Free security systems and free security reviews. Install a home security system from your local ADT Authorized Dealer. Find out more.

<http://www.keepyourhomesafe.com> [Sponsored Link](#)

[Home and Garden shopping at FurnitureFind.com!](#)

Browse a large selection of home and garden furnishings. Find quality, name brand furniture, save 30-50% and get free delivery! Call us today to take advantage of our free personal shopper service.

<http://www.furniturefind.com/> [Sponsored Link](#)

[Buy a Link Now!](#)

Explore More on the About Network!

| | | | | |
|--|--|---|---|---------------------|
| Related Sites Architecture Birding/Wild Birds Gardening Home Repair | <u>Large Rats</u> Exotic Pets Guide Lianne McLeod introduces you to the 30-inch long Gambian Giant Rat. | <u>Decision 2004</u> With Wesley Clark officially in the race, U.S. Politics Guide Anne Linskey looks at all the candidates. | <u>Malcolm X</u> African-American History Guide Jessica McElrath tells us about the life of Malcolm X. | Search About |
|--|--|---|---|---------------------|

[About Us](#) | [Advertise on This Site](#) | [User Agreement](#) | [Privacy Policy](#) | [Kids' Privacy Policy](#) | [Help](#)

Copyright © 2003 About, Inc. About and About.com are registered trademarks of About, Inc. The About logo is a trademark of About, Inc. All rights reserved.